



Using Carts in Healthcare:

a resource guide for reducing musculoskeletal injury

in partnership with Vancouver Island Health Authority



ABOUT OHSAH

The Occupational Health and Safety Agency for Healthcare (OHSAH) in BC, initiated in an Accord between healthcare employers and union representatives, was incorporated on July 5, 1999. OHSAH's board of directors consists of representatives from employer and union organizations, including:

- Health Employers Association of BC (HEABC)
- Hospital Employees' Union (HEU)
- Health Sciences Association (HSA) of BC
- British Columbia Nurses' Union (BCNU)
- BC Government and Service Employees' Union (BCGEU)

Our mission

OHSAH's mission is to:

- work with all members of the healthcare community to develop guidelines and programs designed to promote better health and safety practices and safe early return to work
- promote pilot programs and facilitate the sharing of best practices
- develop new measures to assess the effectiveness of health and safety programs and innovations in healthcare

For more information, contact:

Occupational Health and Safety Agency for Healthcare (OHSAH) in BC

301 – 1195 West Broadway

Vancouver, BC V6H 3X5

Tel: 778.328.8000

Fax: 778.328.8001

Web: www.ohsah.bc.ca

Using Carts in Healthcare:

a resource guide for reducing musculoskeletal injury
in partnership with Vancouver Island Health Authority



OHSAH is grateful to everyone who contributed to the development of *Using Carts in Healthcare: A Resource Guide for Reducing Musculoskeletal Injury (MSI)*.

Special thanks

Special thanks to Nanaimo Regional General Hospital, Trillium Lodge, and West Coast General Hospital for taking the time to implement and try some of the control measures mentioned in this book, and thanks to Vancouver Island Health Authority for leading the process.

Content review participants

- Shelley Boese, Inventory/Distribution Supervisor, Nanaimo Regional General Hospital
- Merle Burton, Maintenance, Trillium Lodge
- Brian Kossey, Safety and Ergonomics Advisor, Vancouver Island Health Authority
- Tracey Newlands, Manager of Occupational, Physiotherapy, and Speech Therapy, Nanaimo Regional General Hospital
- Sandy Ribeyre, Central West Manager of Facilities, Maintenance, and Operations, Vancouver Island Health Authority
- Dr. Dan Robinson, Ergonomist, Robinson Ergonomics Inc.
- Claire Winfield, MSIP Advisor, Vancouver Island Health Authority

OHSAH main contributors

- Elaine J. Lee, Ergonomics Project Coordinator
- Nermin Helal, Ergonomist
- Chris Back, Ergonomics Program Manager
- Dr. Annalee Yassi, Founding Executive Director

© 2005 Occupational Health and Safety Agency for Healthcare (OHSAH) in British Columbia. All rights reserved. OHSAH encourages the copying, reproduction, and distribution of sections of this document to promote musculoskeletal injury prevention in healthcare, provided that OHSAH is acknowledged.

No part of this publication may be copied, reproduced, or distributed for profit or other commercial enterprise, nor may any part be incorporated into any other publication, without written permission of OHSAH.

2005 edition

Using carts in healthcare : a resource guide for reducing musculoskeletal injury.

Includes bibliographical references.

ISBN 0-9687342-3-5

1. Allied health personnel--Wounds and injuries--Prevention.
2. Musculoskeletal system--Wounds and injuries--Prevention.
3. Handcarts. I. Occupational Health and Safety Agency for Healthcare in British Columbia

RD97.5.U84 2005

363.15'72

C2005-905047-0

WHO SHOULD USE THIS GUIDE?

Using Carts in Healthcare: A Resource Guide for Reducing Musculoskeletal Injury (MSI) is for anyone who needs practical information on the safe use of carts in the healthcare environment. This guide focuses on using carts to reduce the physical effort required for transporting supplies and the risk of MSI associated with manual materials handling.

- Employers will find information that will help them collaborate with healthcare workers to prevent injury related to the use of carts. This information will help them detect potential MSI risks and implement effective control measures (for example, designing or selecting suitable carts).
- Workers will find specific health and safety information that will help them carry out their day-to-day tasks safely and efficiently.
- Purchasers will find information to help select carts that are appropriate and effective.
- Facilities maintenance workers will find information related to their role in preventing MSI in workers who use carts.

Look for opportunities to manage the risk of MSI associated with using carts whenever you:

- design new carts
- modify existing carts
- purchase new carts
- respond to incidents related to carts
- develop and implement a proactive risk management program

Many of the recommendations in this guide have been developed and implemented successfully in collaboration with healthcare workers throughout BC. You can photocopy and use material from the appendices (the checklists, tools, and templates) as working copies at your facility.

If you found this guide useful, be sure to check out our other ergonomic publications. Samples of these resources can be downloaded from the OHSAH website (www.ohsah.bc.ca).

TABLE OF CONTENTS

Part 1: Introduction	9
Key points	10
Terms	11
Part 2: Musculoskeletal Injury	13
Common signs and symptoms of MSI	14
Stages of MSI	15
Understanding MSI risk factors	16
Risk factors associated with manual materials handling (MMH)	18
Risk factors associated with using carts	20
Is there a risk of MSI associated with using carts in your facility?	24
Part 3: Handling and Maintaining Carts	27
Safe work practices	28
Work organization	31
Footwear	33
Cart maintenance	34
Part 4: Purchasing and Selecting Carts	35
Cart dimensions	36
Handles	37
Shelves and drawers	42
Casters	45
Wheels	47
Caster and wheel position and configuration	52
Load weight and load capacity	58
Brakes	61
Motorized push pullers	62
Part 5: Environmental Conditions	63
Floors and ground covering	64
Hallways and doorways	65
Inclines	66

TABLE OF CONTENTS

Part 6: Education and Training	69
Sample education module for MSI prevention for workers using carts	70
Guidelines for occupational health and safety training	72
Part 7: Implementation and Evaluation	73
Pre-implementation risk identification and assessment	74
Implementation of the control measure	76
Post-implementation evaluation	77
Appendices	79
Appendix 1	
Signs and symptoms survey	80
Appendix 2	
Risk factor identification checklist	83
Appendix 3	
WorkSafeBC ergonomics requirements	85
Appendix 4	
Pre-purchase checklists and flow charts	88
Appendix 5	
Sample calculations using load weight and load capacity	99
Appendix 6	
Cart identification form (existing carts)	103
Appendix 7	
Implementation guideline	104
Appendix 8	
Stretching routine	105
Appendix 9	
References	106

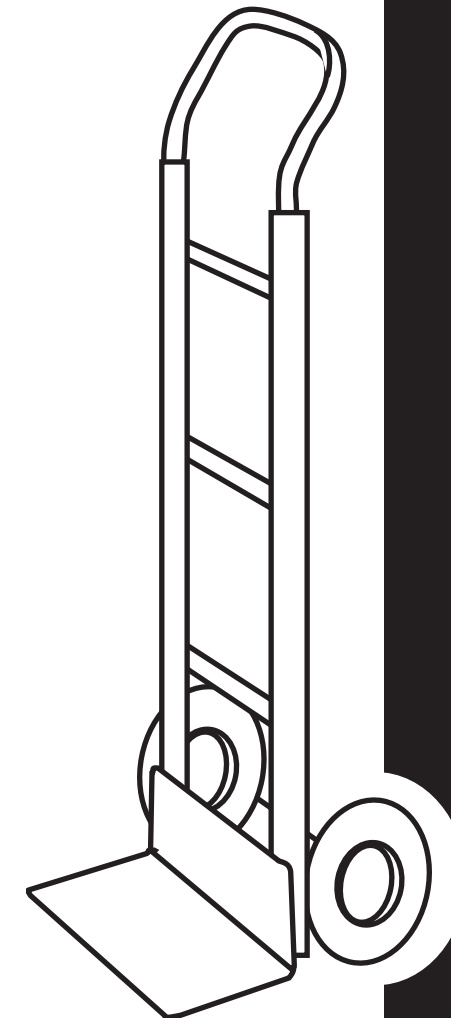

Introduction

This part includes the following sections:

- Key points
- Terms

Here is a summary of the key points that are covered in more detail throughout this guide:

- Common signs and symptoms of MSI include redness, swelling, pain, tenderness, tingling, weakness, and clumsiness.
- Basic risk factors for MSI include force, repetition, awkward posture, static posture, and contact stress.
- Risk factors may also be related to manual materials handling (MMH), including the following tasks:
 - lifting, carrying, and handling objects
 - pushing, pulling, and manoeuvring carts
- It is important to identify high-risk tasks and anticipate the risk factors associated with all tasks.
- Reduce as many of the risk factors within each task as possible. Risk control can be simple and inexpensive.
- Evaluation and worker consultation are important to ensure that implemented control measures are effective and that they have a positive impact for all workers.
- Carts can reduce the risk associated with MMH, if they are selected carefully and maintained.

Ergonomics

Ergonomics is the application of knowledge about human capabilities and limitations to the design of work, equipment, tools, work environments, and work organization to optimize human well-being and performance.

Musculoskeletal injury (MSI)

The Occupational Health and Safety Regulation defines musculoskeletal injury (MSI) as “an injury or disorder of the muscles, tendons, ligaments, joints, nerves, blood vessels or related soft tissue including a sprain, strain and inflammation, that may be caused or aggravated by work.” MSI is sometimes also referred to as work-related musculoskeletal disorder, cumulative trauma disorder, repetitive strain injury, or activity-related soft tissue disorder.

Some common MSIs associated with carts include the following:

- fingers or hands caught in, on, or between a cart and another object
- toes, feet, or lower legs bumped or crushed by a cart
- arm, shoulder, or back strain

MSI risk factors

MSI risk factors are the physical demands of a task that contribute to the overall risk of MSI.

Control measure

A control measure is a solution that is implemented to eliminate or minimize the risk of MSI. Always try to eliminate the hazard wherever practicable. Control measures may include the following:

1. engineering controls
2. administrative controls
3. personal protective equipment (PPE)

Manual materials handling (MMH)

Manual materials handling (MMH) is the transport or support of loads by hand or bodily force. MMH often combines pushing, pulling, lifting, lowering, carrying, and holding. Approximately three out of every four Canadians whose jobs involve MMH sustain a back injury at some point in their working lives.

Carts

A cart is a type of MMH device used to minimize the physical effort required to perform MMH tasks. For example, rather than lift and carry ten individual boxes from one location to another, a worker can use a wheeled cart to support the weight of the boxes.

Acute injuries

Acute injuries are injuries that occur immediately as a result of a single traumatic event. Examples of incidents that could cause acute injuries include:

- items falling off a cart and landing on your foot
- slipping on a wet floor and twisting your ankle

Chronic injuries

Chronic injuries are injuries that develop over time as a result of repeated trauma or overuse of a body part. Symptoms develop in the affected part and the injury may persist or get worse if not treated properly. Examples of chronic injuries that may develop over time include:

- shoulder, elbow, or wrist tendinitis resulting from pushing a heavy cart frequently
- wrist pain resulting from supporting the weight of objects on a dolly
- back pain resulting from pushing a loaded platform truck every shift

The worst-case scenario is an injury that leaves the worker unable to perform his or her everyday duties and tasks, both at the workplace and elsewhere.

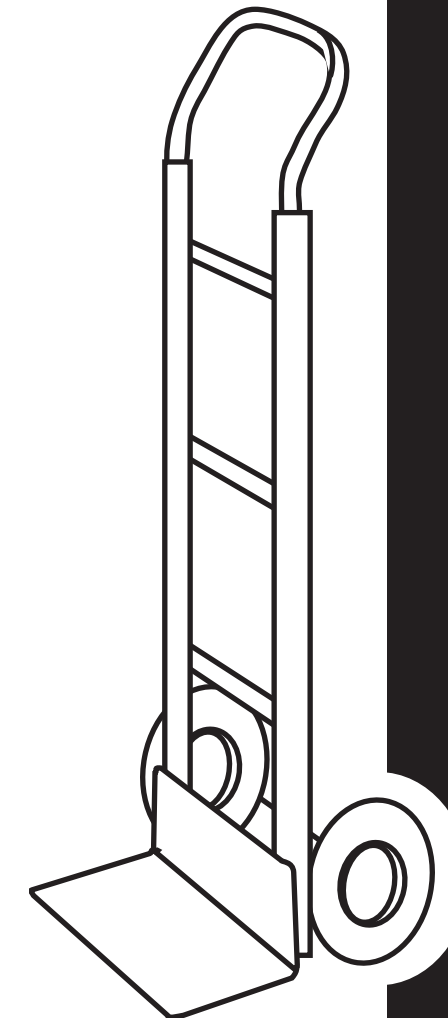

2

Musculoskeletal Injury (MSI)

This part provides information on musculoskeletal injury (MSI). It includes the following sections:

- Common signs and symptoms of MSI
- Stages of MSI
- Understanding MSI risk factors
- Risk factors associated with manual materials handling (MMH)
- Risk factors associated with using carts
- Is there a risk of MSI associated with using carts in your facility?

Work-related MSI can make normal work routines uncomfortable and even painful. This can lead to stress or dissatisfaction at work, reduced productivity, an inability to perform some or all work duties, and even difficulty with activities at home. Early recognition of common signs and symptoms of MSI can help prevent injuries from getting worse.

signs

Signs are things you can see, such as swelling or redness. Typical signs of MSI include the following:

- redness of the skin
- swelling around the injured area
- loss of full, normal joint movement

symptoms

Symptoms are things you can feel but cannot see, such as numbness, tingling, or pain. Typical symptoms of MSI include the following:

- clumsiness
- weakness
- tenderness
- tingling
- numbness
- heaviness
- heat or burning
- pain (dull, sharp, or shooting)

MSI signs and symptoms tend to follow the stages described in Table 2.1. Some MSIs progress rapidly from early to late stages. A worker who experiences early signs or symptoms of MSI should report them to a supervisor or manager immediately and fill out an injury or incident report form. If signs or symptoms persist for more than a few days, the worker should see a medical professional.

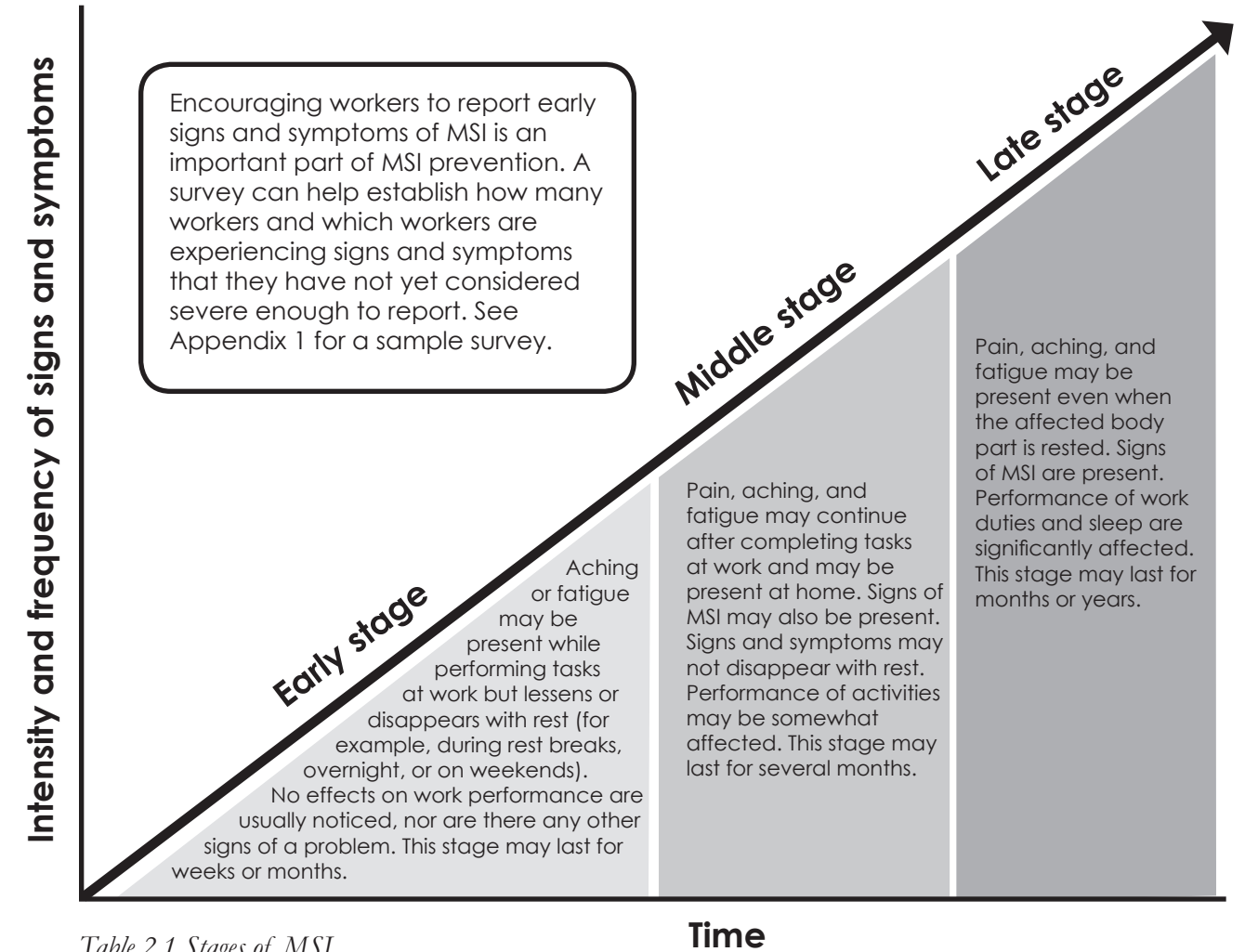

Table 2.1 Stages of MSI

Understanding risk factors and identifying where they might occur is the first step in preventing MSI. When assessing the degree of risk, it is important to ask three basic questions:

1. What is the intensity or magnitude of exposure to the risk factor (how much)?
2. What is the frequency of exposure to the risk factor (how often)?
3. What is the duration of exposure to the risk factor (how long)?

If a task presents high levels of any one risk factor or presents multiple risk factors, the level of risk can increase greatly. This section describes the following risk factors:

- force
- repetition
- awkward posture
- static posture
- contact stress

Force

Forceful exertion increases the body's energy demands and physically stresses the muscles, tendons, ligaments, and joints, which increases the risk of injury. For example, pushing a heavy cart over an obstacle such as a hose or electrical cord requires forceful exertion.

Repetition

A repetitive task is a task that uses the same muscles repeatedly. For example, continually turning a cart to navigate through a cluttered hall can be repetitive.

Awkward posture

Awkward posture occurs when the body has to work in a position that is not considered neutral. Neutral postures are those in which the muscles, tendons, ligaments, and joints function optimally and require the least amount of effort to maintain. Awkward posture increases the amount of stress on muscles, tendons, ligaments, and joints; it is of greatest concern when it is sustained for prolonged periods or combined with other risk factors. What is considered awkward is different for each body part.

Static posture

Static posture is a body position held for a prolonged period. The level of risk that static posture presents depends on the level of muscular exertion and the posture itself. For example, bending forward to push a platform truck with a handle that is too low places the back in a static (as well as awkward) posture. Muscles that are exerting force may tire more quickly in a static posture than when moving.

Contact stress

Contact stress occurs when body parts come into contact with hard or sharp objects, which concentrates force on the underlying tissues. This interferes with normal blood flow and nerve function. This type of stress can result in injury to tissues beneath the skin. For example, handling the edge of a cart because it has no handle can cause contact stress on the hands.



Figure 2.1 Leading a cart by pulling with one arm can place the shoulder in an awkward posture.

RISK FACTORS ASSOCIATED WITH MANUAL MATERIALS HANDLING (MMH)

Manual materials handling (MMH) includes pushing, pulling, lifting, lowering, carrying, and holding loads. These activities may present any of the basic risk factors: force, repetition, awkward posture, static posture, and contact stress. This section discusses risk factors related to handling materials without the use of carts.

Force

The amount of force exerted during MMH depends on the following:

- worker characteristics (body weight and height)
- load characteristics (weight, size, and shape)
- task requirements (amount of force applied and duration of exertion)
- handling technique (using one or two hands; foot distance and stance)
- environmental conditions (type of floor surface)

Forceful exertion is most likely to affect the back, shoulders, wrists, and hands.

Repetition

Repetition may be a risk factor during MMH if similar tasks are repeated throughout the day such as folding linen or stocking shelves. These tasks may affect the worker's back, shoulders, and wrists.

Tasks that require kneeling, squatting, or crouching may also affect the legs. The amount of risk that repetition presents depends on the following:

- frequency of tasks
- amount of rest between tasks
- body parts used

Awkward posture

MMH may result in awkward posture if the task involves reaching or twisting. For example, bending at the waist to lift something from the ground may cause an awkward back posture; pulling a box from an overhead shelf may cause an awkward shoulder posture. MMH may also result in awkward postures of the neck, wrists, and hands. Awkward posture may be affected by the following:

- worker characteristics (body height)
- load characteristics (weight, size, shape, and handles)

RISK FACTORS ASSOCIATED WITH MANUAL MATERIALS HANDLING (MMH)

- task requirements (amount of force applied and duration of exertion)
- handling technique (bending at the lower back or the knees and hips; using one or two hands; foot distance and stance)
- environmental conditions (heights of shelves or obstacles)

Static posture

Static posture may be a risk factor during MMH if positions are held for a long time (for example, when carrying a load over a long distance). Static posture is most likely to affect the back, shoulders, wrists, and hands. Static posture may be affected by the following:

- duration the position is held
- amount of force applied

Contact stress

Contact stress may be a risk factor during MMH if the object being handled has hard or sharp edges (for example, handles cut into the side of a cardboard box). Contact stress may also be a risk factor if kneeling or resting the elbows on a hard surface is required. Contact stress is most likely to affect the hands, elbows, and knees.

Carts are often used to minimize the physical effort required to perform MMH tasks. For example, rather than lift and carry a piece of heavy equipment from one location to another, a worker may use a cart to move it.

Although using a cart is a control measure that reduces the amount of carrying required, it is still considered an MMH task. Risk factors associated with MMH are not eliminated by using a cart, but they can be minimized by selecting the appropriate cart for the task and using it properly.

Loading a cart involves lifting, lowering, and carrying tasks. Manoeuvring a cart involves pushing and pulling tasks. These activities may present the same risk factors as any other MMH activity: force, repetition, awkward posture, static posture, and contact stress. This section discusses these risk factors as they relate to the use of carts for handling materials.

Although using a cart is a control measure, it is still a manual materials handling task that presents some risk of injury.

Force

Handling carts may require forceful exertion when loading, unloading, pushing, pulling or manoeuvring. The amount of force exerted depends on the following:

- cart characteristics (weight, size, location of handles, and type of casters)
- load characteristics (weight, size, and shape)
- handling technique (using one or two hands)
- task requirements (distance travelled and method of loading and unloading)
- environmental conditions (type of floor surface, and inclines or obstacles)

Repetition

Repeated handling and manoeuvring of carts may result in repetitive shoulder and wrist motions. Loading and unloading a large amount of materials from carts may also result in repetitive motions.

Awkward posture

The positions of handles and shelves on carts have the greatest influence on worker posture. Awkward posture may be affected by the following:

- cart characteristics (size, design and location of handles, and location of shelves)
- load characteristics (size and shape, and whether the load obstructs the worker's view)
- location on the cart where force is applied
- method of pushing or pulling
- ability of workers to see over or around the cart when pushing

Static posture

Pushing, pulling, or steadying carts over long distances or for long durations may result in static postures of the back, neck, shoulders, wrists, and hands. Static posture may be affected by the following:

- duration the position is held
- amount of force applied

Contact stress

Contact stress may be a risk factor with carts that have hard or sharp edges such as a square corner on the cart handle. Contact stress may also be a risk factor if workers kneel or rest their elbows (for example, to access the cart load). When workers are using carts, contact stress is most likely to affect the hands, forearms, elbows, and knees.

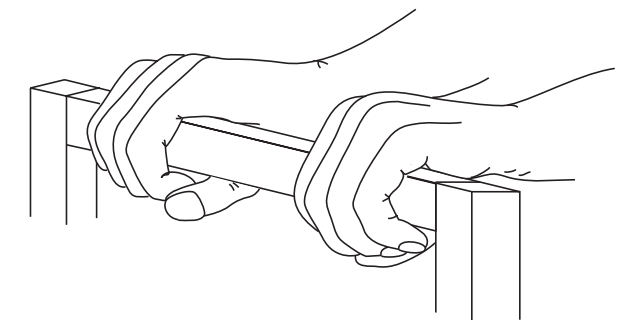

Figure 2.2 Square or sharp-edged cart handles may present a risk of contact stress.

Other elements that influence risk factors

Other elements that may affect the level of risk associated with using carts are divided into the following categories: worker characteristics, choices made by workers, cart and equipment design, organization of work, and environmental conditions.

Worker characteristics

- height and weight
- age
- gender
- strength
- posture
- physical fitness
- history of injury

Choices made by workers

- equipment selection
- selection of procedures, techniques, and postures
- education and training

Cart and equipment design

- stability
- size and weight
- height of handles
- orientation of handles (for example, horizontal or vertical)
- type of handles (for example, square, rounded, or conical)
- design and configuration of casters and wheels (for example, number of wheels and swivel or rigid casters)

Organization of work

- work recovery cycles
- task variability
- work rate

Task characteristics

Various elements can influence risk factors including task characteristics. Some of the influences are as follows:

- distance the cart is moved
- force required to start moving the cart, keep it moving, or stop it
- direction and nature of movement (navigation requirements)
- duration and frequency of pushing and pulling tasks
- relationship of pushing and pulling tasks to other job activities
- types of materials loaded onto and unloaded from the cart
- timing and sequence of loading and unloading requirements

Environmental conditions

- characteristics of surfaces (for example, the types of flooring and floor transitions)
- inclines
- hazards (for example, dirt, garbage, water, raised door frames, and other obstacles)
- temperature
- lighting

Employers should follow this seven-step ergonomics process to eliminate or minimize risks of MSI associated with using carts.

Step 1. Consultation

During each step, consult with your:

- Joint Occupational Health and Safety Committee (or worker health and safety representative)
- Health and Safety Department (for example, an occupational health and safety advisor or ergonomist)
- workers, who can help identify concerns and contribute to purchasing decisions related to carts

You are not expected to consult with every worker. Select a representative sample of workers who carry out the work being assessed, including workers with signs or symptoms of MSI. Consultation may also include managers, supervisors, first aid attendants, and union representatives.

Step 2. Education

Educate workers so that they can do the following:

- identify risk factors associated with MMH tasks and using carts
- recognize early signs and symptoms of MSI
- recognize the potential health effects of MSI

Step 3. Risk identification

Identify the MMH tasks and cart-handling tasks that pose a risk of MSI, and identify the risk factors associated with those tasks. See Appendix 2 for a risk factor identification checklist.

Step 4. Risk assessment

Assess identified risk factors to determine the degree of risk to workers. To determine the degree of risk, ask the three basic questions (see page 16) relating to intensity of exposure (how much?), duration of exposure (how often?), and frequency of exposure (how long?) .

Step 5. Risk control

Risk control measures generally fall into one of three categories listed below. Whenever possible, engineering controls or administrative controls should be used first to eliminate or minimize exposure to the risk factors. If those types of control measures are not feasible, personal protective equipment (PPE) can be considered as a control measure.

1. Engineering controls

Can you physically modify the equipment or environment? For example, modify cart handles to allow taller and shorter workers to use them comfortably.

2. Administrative controls

Does the task need to be done (elimination)? Is there a different approach to achieve the same objective (substitution)? For example, instead of having supplies delivered to a central receiving area to be distributed by your facility staff, have the supplier deliver them directly to the wards where they are needed. Can the work be organized or performed differently? For example, use job rotation to reduce each worker's duration of exposure to a specific risk, or improve work techniques so that workers use different body parts during shifts.

3. Personal protective equipment (PPE)

Personal protective equipment should only be used as a last resort, when engineering or administrative controls are not practicable. For example, ensure that workers wear appropriate footwear to prevent slipping when manoeuvring carts and wear gloves to protect against contact stress when pushing.

Step 6. Training

Train workers to use the control measures to make their jobs safer.

Step 7. Evaluation

Conduct an evaluation in any of the following instances:

- after implementing control measures (including the use of carts to control risks associated with MMH) — to determine their effectiveness at minimizing the risk of exposure to MSI
- whenever workloads or processes change — to assess changes in the risk of MSI
- whenever an injury or other incident occurs — to prevent reoccurrence

3

Handling and Maintaining Carts

This part provides information that will help minimize the risk of MSI when using carts. It includes the following sections:

- Safe work practices
- Work organization
- Footwear
- Cart maintenance

The first three sections describe potential control measures for eliminating or minimizing risk factors. Implement the control measures that best fit your needs. See Appendix 2 for a risk factor identification checklist that will help you determine which aspects of cart use are exposing workers to risk factors for MSI. See Appendix 4 for a pre-purchase checklist that will help you make informed decisions when purchasing new carts.

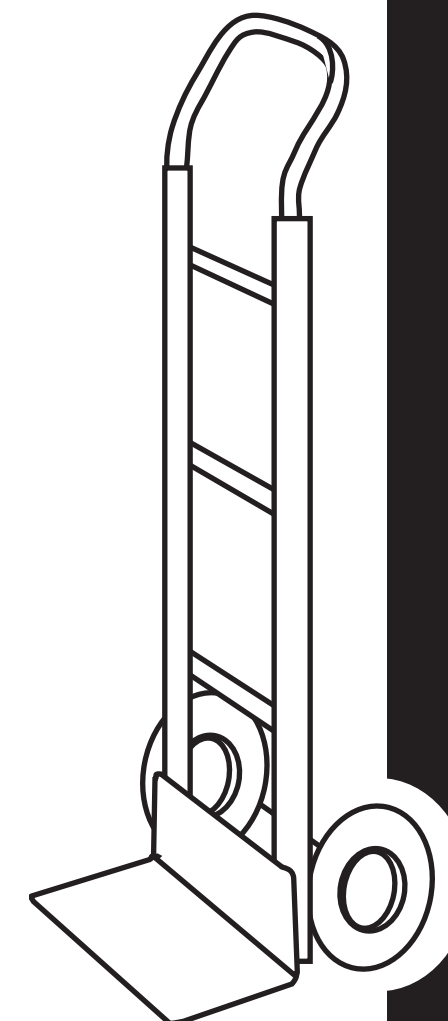

Good body mechanics can help workers use less force to carry out tasks and prevent awkward postures, both of which will reduce the risk of MSI. This section includes safe work practices that will help promote good body mechanics when pushing and pulling carts.

Workers should consider the following recommendations for pushing and pulling carts:

- Plan your route before moving the load.
- Push rather than pull whenever possible.

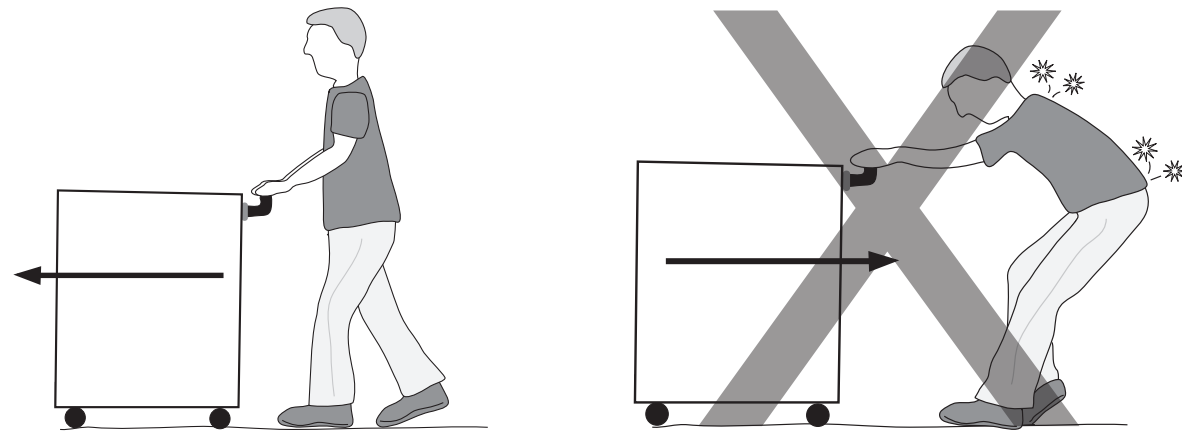

Figure 3.1 Pushing is generally safer than pulling. Pulling puts more strain on the lower back and shoulders.

- Bend your knees slightly and move the load by shifting your weight. Move the load with your whole body by walking forward, rather than planting your feet and pushing with your arms only.
- Keep your elbows close to your body. Keep your hands at or slightly below elbow height. Keep your feet shoulder width apart.

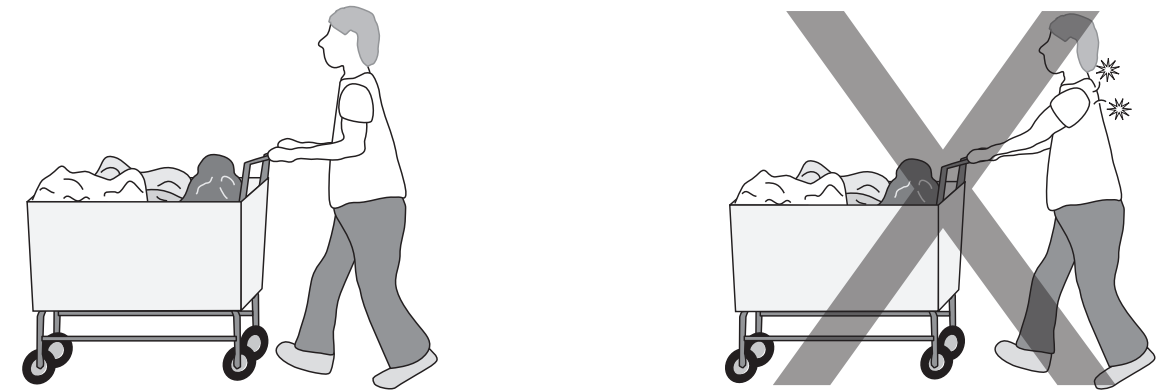

Figure 3.2 Keeping your elbows close to your body will help prevent shoulder strain.

- Tighten your abdominal muscles slightly before beginning to push. You should be able to breathe and talk, but maintain some tightness in your abdomen to help stabilize your lower back.
- Face the cart. Point your toes in the direction you are moving to avoid twisting your back.
- Always use two hands when pushing or pulling.

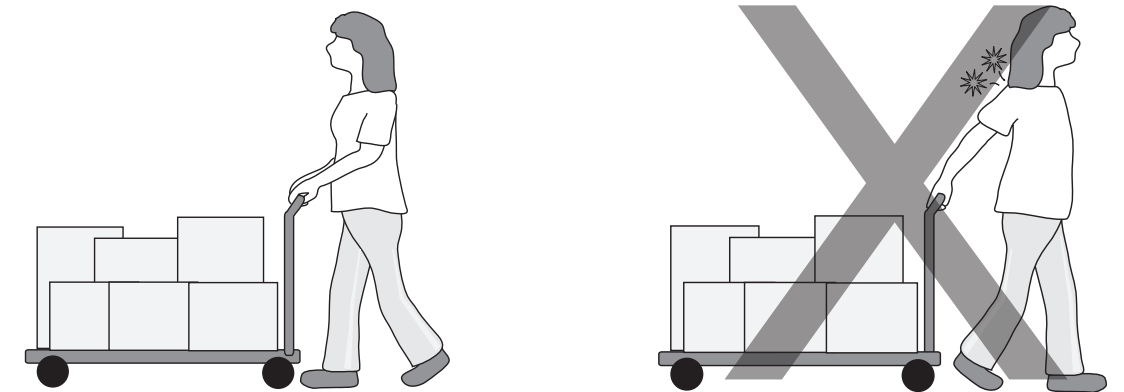

Figure 3.3 Facing the cart and pushing with two hands rather than pulling with one arm will help prevent shoulder strain.

- Put one foot in front of the other. Shift your body weight from the back leg to the front leg to start moving the cart.
- Take small steps when turning corners to avoid twisting your back.
- Keep your body close to the cart.
- Stand upright while pushing.

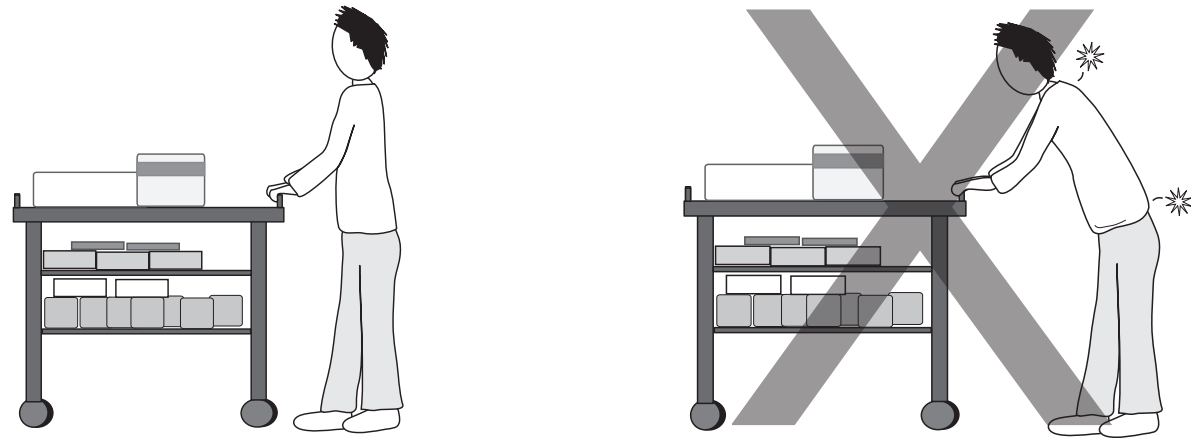

Figure 3.4 Standing upright while pushing will help prevent an awkward static posture.

- Use smooth motions; avoid jerky movements.
- Grasp the handles of the cart to avoid awkward hand postures associated with gripping the corners of the cart.
- Avoid leaning against the edge of the cart or pushing it with your knees or thighs.
- Change your grip by varying between palms up and palms down, as well as alternating between horizontal and vertical grips.
- Alternate working positions to avoid overusing any single muscle or group of muscles.
- Maintain clear visibility when pushing the cart. Poor visibility may cause you to twist or use awkward postures. Do not pile items so they interfere with visibility. A maximum load height of 140 cm (55 in.) will accommodate most workers; otherwise the cart should be designed for pulling or for two workers to push from the sides.
- Shift your body weight from the front leg to the back leg to stop moving the cart.

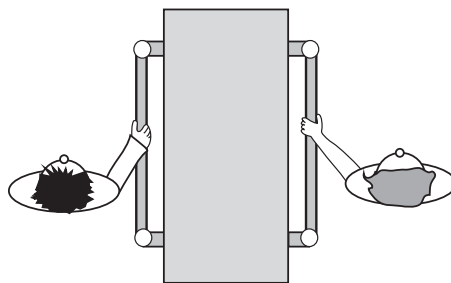

Figure 3.5 If clear visibility is not possible, use a cart designed for two workers to push from the sides.

The way in which work is organized influences the amount of force exerted, the postures required, the duration of tasks, and the rate of repetition of tasks. Workers should consider the following general guidelines to reduce the risk of MSI associated with manual materials handling:

- Make several smaller, lighter trips when moving materials, rather than one large, heavy trip.
- Alternate or eliminate tasks to decrease the frequency of handling carts.
- Pace yourself when performing repetitive tasks.
- Store items between knee and shoulder height whenever possible. Store frequently used items at approximately waist height.

Job rotation

Rotate workers through a variety of tasks or duties to help vary postures, to reduce exposure to stressful tasks, and to reduce exposure to risk factors (as well as prevent boredom). Employers and workers should consider the following job rotation recommendations:

- Vary tasks such as handling carts and paperwork throughout the day.
- Alternate between tasks that call for standing or walking and tasks that allow sitting.
- Rotate workers through the heaviest pushing and pulling tasks to reduce the risk to any one worker.

Stretching

Stretching improves blood circulation through the muscles. It may help relieve muscle tension, develop flexibility, and increase body awareness. Workers should stretch on a regular basis throughout the day (especially if they are working in static postures), not just when they feel muscle tension or discomfort. For a stretching routine, look for the OHSAAH Stretch It Out! poster, which may be displayed in your facility, or see Appendix 8 for a reproduction of this poster.

Stretching is only one component of injury prevention. General fitness, including aerobic exercise and muscle strengthening, is also important. Before beginning a stretching or fitness routine, consult with your doctor, especially if you have an existing injury or condition.

Workers should consider the following stretching recommendations:

- Warm up first by slowly swinging your arms and moving your legs for about 20–30 seconds.
- Stretch for a few minutes before starting work to prepare your muscles for work.
- Hold each stretch for 20–30 seconds.
- Stretch muscles that are being used for a particular job or task.
- Stretch only as far as is comfortable. Stretching should not hurt.
- If you feel pain, stop the stretch. If the pain persists, consult with your facility's first aid attendant or your doctor.
- Always stretch using slow and controlled motions. Never bounce or stretch rapidly.

Rest breaks and micro-pauses

Workers should take rest breaks and stretch regularly throughout the day to prevent fatigue and give muscles a chance to recover. Take frequent micro-pauses of 10–15 seconds. During micro-pauses, change your posture and stretch briefly. A micro-pause stretch is shorter in duration than a normal stretch but is still beneficial. It is also important to take longer breaks when you feel fatigued or your muscles are sore.

Footwear may affect a worker's ability to use a cart safely. For example, footwear with poor or worn treads may increase the likelihood of slipping. Footwear should provide enough cushioning and support to relieve stress on the back and legs. Footwear should fit properly and have non-slip soles.

Tips for buying footwear

Consider these guidelines when buying footwear:

- Buy footwear late in the afternoon when your feet are swollen and at their maximum size.
- Bring along an old pair of work shoes to compare.
- If you wear orthotics, bring them along and try on the shoes with the orthotics inserted.
- If your feet are different sizes, buy shoes to fit the larger foot.
- Shoes should fit snugly without being too tight. There should be about 1.25 cm (0.5 in.) of room between your big toe and the end of the shoe.
- Ensure that the footwear meets workplace standards [for example, local policies or WorkSafeBC (the Workers' Compensation Board) requirements].

Wear and tear

The frequency with which footwear needs to be replaced depends on how fast wear and tear occurs. The slip resistance of the outsoles may start to decline after the shoes are worn for the first time. Over time, the outsoles will deteriorate and the midsoles will break down and lose their cushioning capabilities.

Preferred outsoles include vinyl with neoprene and supple rubber. If walking is required in wet areas, use shoes with pronounced tread; hard-soled shoes with shallow tread are not recommended.

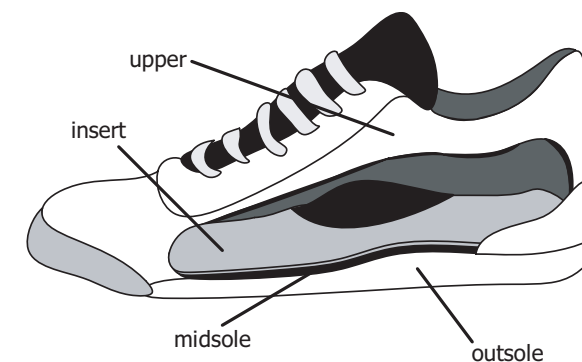

Figure 3.6 Footwear should meet any applicable workplace standards and be constructed of durable materials.

Regular cart maintenance will help ensure that all worn or broken parts are replaced in an efficient and timely manner. Proper maintenance and use of a cart will extend its life and make it more effective and safer.

Cart maintenance should include the following components:

- identification of carts
- regularly scheduled preventive maintenance
- a clear procedure for identifying and labelling damaged or malfunctioning (out-of-service) equipment
- timely repair and replacement of damaged equipment

Identification

All carts from each department should be identified. The make, model, supplier, and supplier support (for example, regular maintenance) information should be placed in a location that is accessible to all workers. See Appendix 6 for a usable cart identification form.

Preventive maintenance program

Establish a regularly scheduled preventive maintenance program, with input from equipment manufacturers. Preventive maintenance should include the following:

- Clean wheels and bearings on hand carts and other mechanical aids.
- Lubricate casters and wheels as necessary.
- Monitor tread wear, corrosion, and other changes that might bind the wheels and increase the forces required to move the carts.
- Replace worn or defective wheels and casters.
- Check that all mechanical aids are working efficiently (for example, brakes or directional locks).
- Maintain tire pressure in pneumatic tires.

Out-of-service carts

Establish an “out-of-service” policy for tagging equipment that does not work. Workers should report out-of-service carts immediately to supervisors and maintenance workers. Out-of-service equipment must be repaired before being used again.

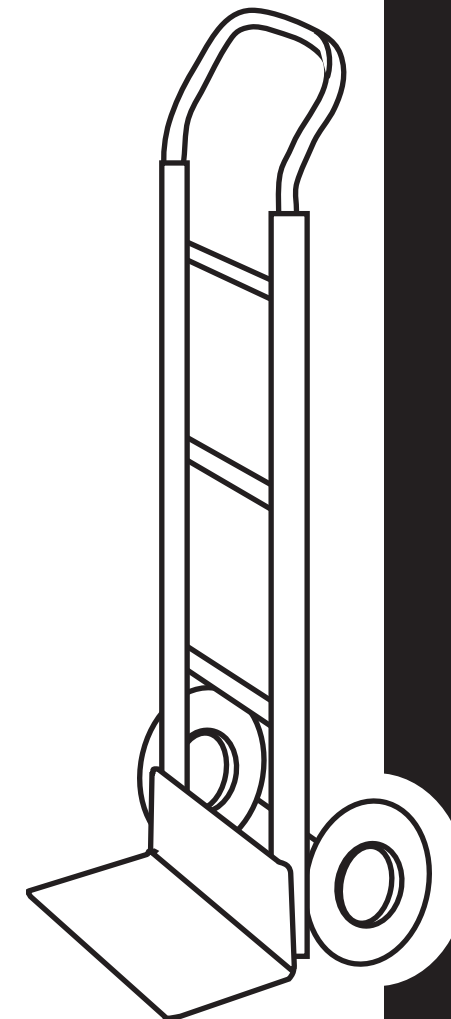

4

Purchasing and Selecting Carts

This part is divided into sections that deal with specific components and features on carts. Each section provides information on designs and available features that will help guide you when you are purchasing or selecting carts to minimize risk factors for MSI. This part includes the following sections:

- Cart dimensions
- Handles
- Shelves and drawers
- Casters
- Wheels
- Tires
- Caster and wheel position and configuration
- Load weight and load capacity
- Brakes
- Motorized push-pullers

The size and shape of a cart will influence the way workers handle it and the amount of force they will exert to move it. Consider the following guidelines when selecting or purchasing a cart:

- The cart should be no wider than 1 m (39 in.) and no longer than 1.3 m (51 in.) to ensure that workers can turn it in most aisles.
- The cart should be no taller than 1.4 m (55 in.) when loaded to ensure that workers can see over the cart while pushing.

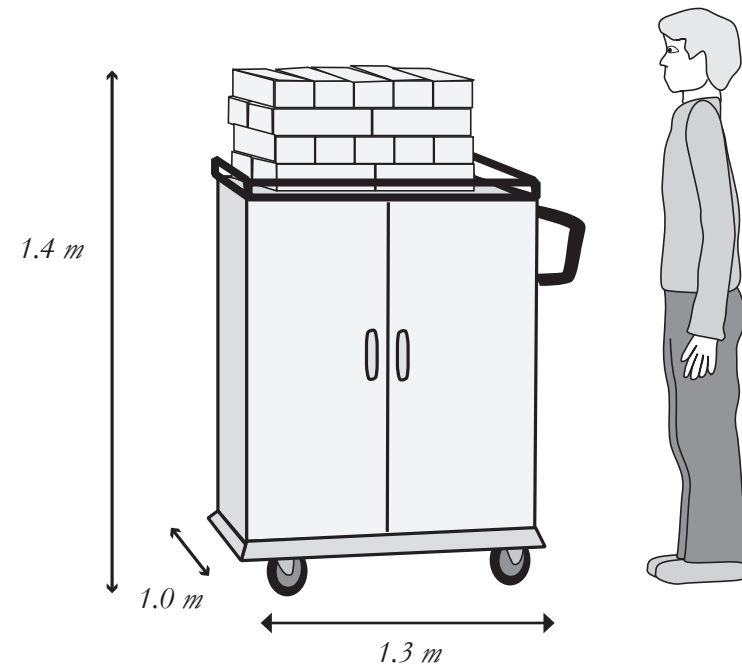

Figure 4.1 The dimensions of a cart, when loaded, should not exceed 1 m wide, 1.3 m long and 1.4 m tall.

All carts should have a designated handle or handhold to help workers manoeuvre the cart safely. The presence and design of handles are two of the most important elements for promoting good posture when workers are handling a cart. Handle design also affects the amount of force that workers must exert when handling the cart. This section includes information on handle orientation; height, width, and positioning; diameter; and material.

Orientation

Horizontal and Vertical

A horizontal handle running between two vertical grips allows for a variety of postures and variation in the width of hand placement. Horizontal handles allow workers to determine their own gripping distances according to their size and strength.

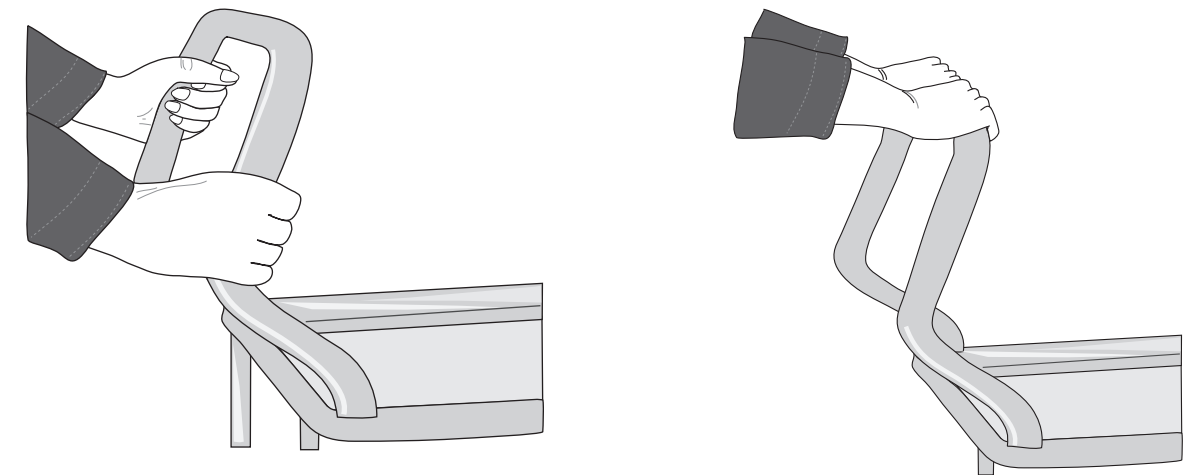

Figure 4.2 A horizontal handle running between two vertical grips allows the worker to use a variety of gripping postures.

Vertical

If a horizontal handle is not possible, a vertical handle is a good option because it allows workers to choose a handle height that is appropriate for them. Vertical handles are best used on carts that are narrower than 51 cm (20 in.).



Figure 4.3 Vertical handles allow both shorter and taller workers to minimize awkward postures while using the same cart.

Height, width, and positioning

Handles should be located between waist and shoulder height, at a height that allows a comfortable standing posture. Typically this is 91–112 cm (36–44 in.) from the ground. In general, the more weight there is on a cart, the higher the handle should be within the recommended height range. Handles should be narrower than the cart itself to minimize scraping and pinching of fingers.

Handles should be positioned on the end of the cart that has swivelling wheels. However, it is useful to have handles at both ends so workers can change their pushing direction without having to turn the cart around.

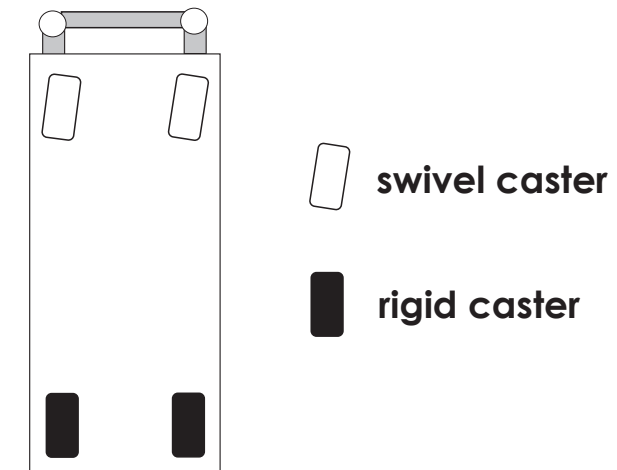

Figure 4.4 If a cart only has a handle on one end, the handle should be positioned over the swivelling wheels.

If workers need to pull a cart, they should use a T-bar handle that is at least 91 cm (36 in.) above the ground.



Figure 4.5 T-bar handles are an appropriate choice for carts that need to be pulled.

If the load on the cart obstructs visibility, workers should use a cart with a vertical pole or add a vertical pole to a cart (similar to a bellhop's cart) so they can push the cart from the side, near the front. If the load on the cart is heavy, ensure that there are two people pushing the cart, one on either side of the cart (refer to page 30, fig 3.5).



Figure 4.6 Carts with vertical poles are useful when the load is high enough to obstruct visibility from the back.

Diameter

The diameter of a handle can affect the effort required to grasp it. Handle diameters should be approximately 4 cm (1.5 in.). Handles should also have rounded edges to minimize contact stress.

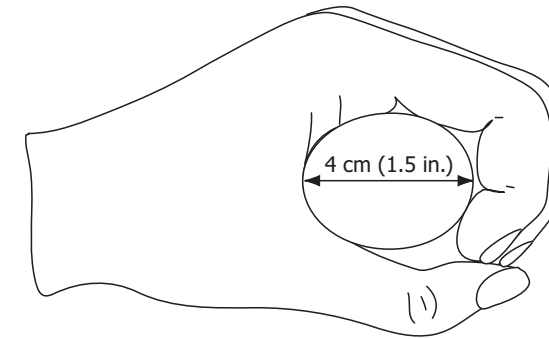
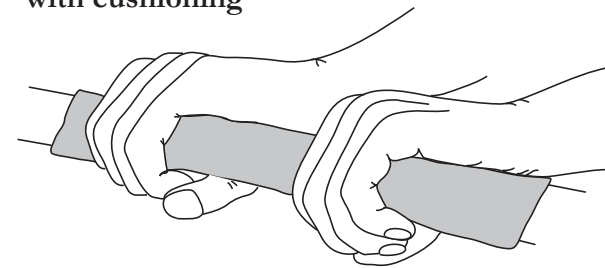

Figure 4.7 Handles should be rounded, with a diameter of approximately 4 cm (1.5 in.).

Material

Handles should be textured to improve grip. Avoid handles with finger grooves because they often do not accommodate a range of hand sizes. Cushioned handles will reduce contact stress and increase comfort when workers are handling the cart for long periods or with a heavy load. Cushioned handles can also reduce vibration on the hands.

with cushioning



without cushioning

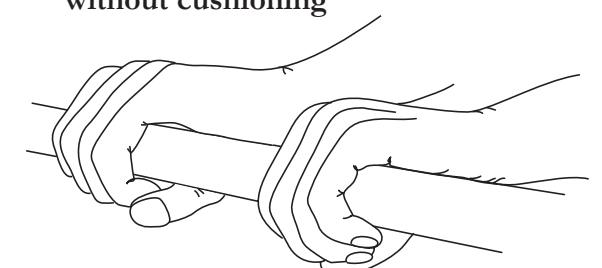

Figure 4.8 Cushioned handles can reduce contact stress and vibration, and increase worker comfort.

The heights of shelves and drawers can affect worker posture. Work surfaces that are too high can lead to awkward shoulder postures while workers are loading and unloading, as well as awkward neck and back postures if the load impedes visibility while workers are pushing. Work surfaces that are too low can also lead to awkward neck and back postures.

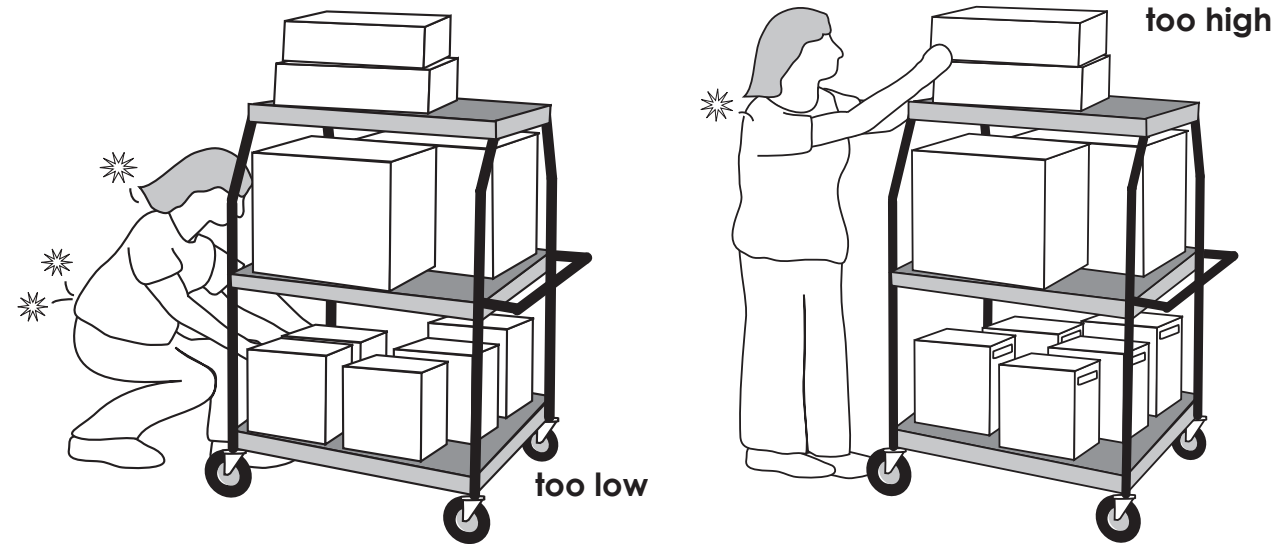
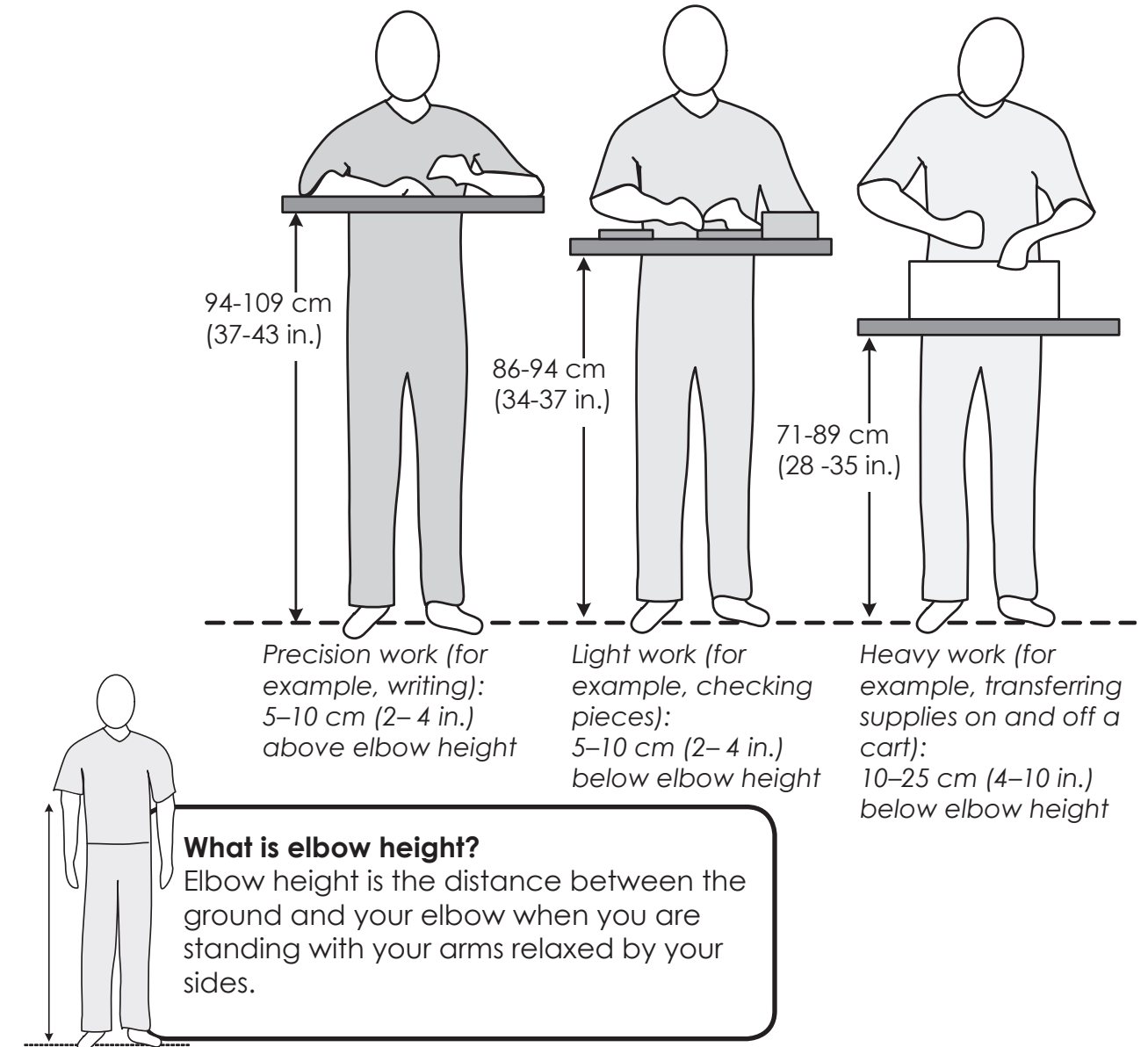

Figure 4.9 High shelves can lead to awkward shoulder postures. Low shelves can lead to awkward neck and back postures.

Shelves and drawers that are adjustable to suit individual workers are preferred. If this is not practical and there is a wide range in worker heights, provide two or more carts with different work surface heights to accommodate different workers. Consider each task associated with the cart to help determine the most appropriate work surface heights. Ask the following questions:

- What is the size of the item being handled?
- How heavy is the item?
- What are workers doing with the item (for example, lifting it, reading labels, or checking pieces)?

Figure 4.10 Working heights for specific kinds of tasks



General guidelines

Consider the following guidelines for using shelves and drawers on carts:

- Workers should place heavier items on shelves closest to waist height. Lighter items should be placed on lower and higher shelves.
- The best height for shelves or drawers on carts is 60.5–122.5 cm (24–48 in.).
- Items being handled on the upper shelf should be no higher than the shoulder height of the shortest worker.
- The lower shelf or drawer should be no lower than the knee height of the tallest worker.
- Workers should be encouraged to use only those shelves that are between their knee and shoulder heights when using carts.
- Carts should not have deep shelves or other obstacles (for example, small clearances between shelves) that make workers adopt awkward postures or an extended reach to access objects on the shelves.

A caster is the hardware that mounts a wheel to a cart. Casters are either rigid or swivel. Rigid casters are fixed so they do not rotate. Swivel casters have bearings mounted in a swivel frame so they can rotate 360 degrees. Swivel casters may include a directional lock so they can double as rigid casters as needed.

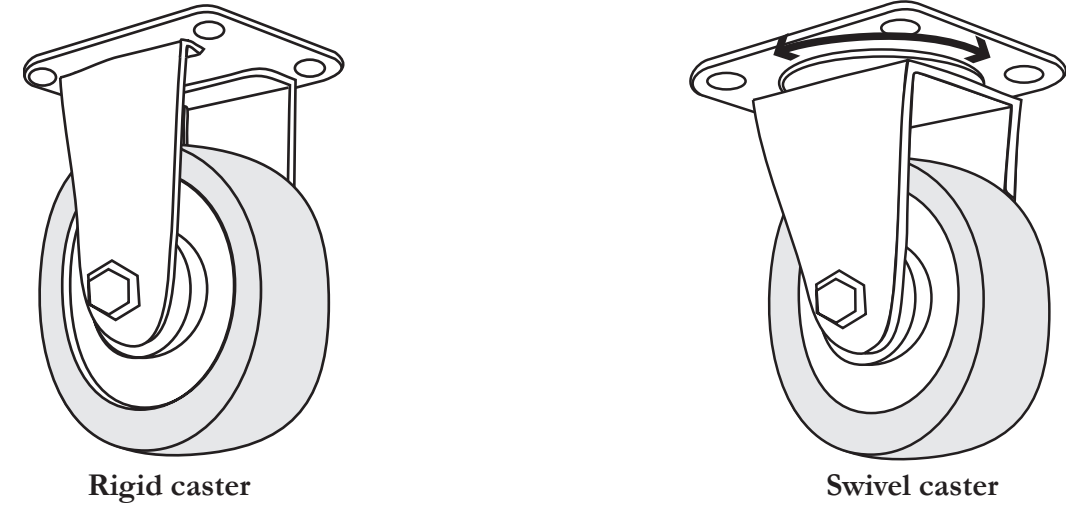

Figure 4.11 Rigid casters are fixed and do not rotate. Swivel casters have bearings that allow them to rotate.

Swivel casters are equipped with one of the following two types of bearings:

- sealed ball bearings, which roll easily and require little maintenance
- roller bearings, which are common but require regular lubrication

Carts that are frequently washed or used in wet areas (for example, in kitchens) should be equipped with waterproof casters that have sealed bearings.

Load weight

Casters with ball bearings are recommended for loads over 115 kg (250 lb.). When considering load weight, it is important to include any impacts or shock loads that the caster will be subjected to. Shock load is produced by dropping a load on the cart or rolling the caster over an obstacle (for example, an elevator sill) or a surface that causes vibration. For more information on load weight, see page 57 & 98.

Swivel radius

Swivel radius is the measured horizontal distance from the vertical centre line of the kingpin to the outside edge of the tire tread. The swivel radius specifies the minimum clearance required for a mounted caster to swivel 360 degrees. The larger the swivel radius, the easier the caster will rotate.

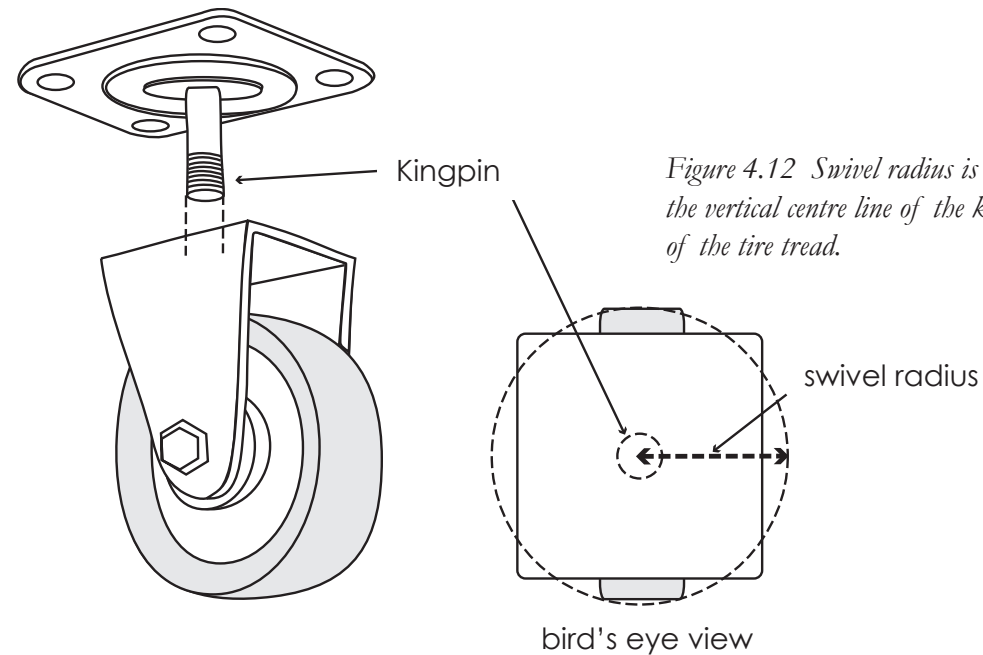

Figure 4.12 Swivel radius is measured horizontally, from the vertical centre line of the kingpin to the outside edge of the tire tread.

A wheel is the rolling component within a caster that interacts with the axle. The type of wheel used affects the amount of force required to start moving a cart and keep it moving. This is referred to as rollability. Rollability is influenced by several variables, including wheel diameter, width, shape, and firmness (described in this section), as well as the type of bearings and the weight of the load. When selecting wheels, consider the most common conditions that the cart will be used in.

Diameter

The diameter of a wheel is one variable that determines ease of mobility and manoeuvrability. In general, the taller the wheel, the easier it is to roll the cart.

Consider the following guidelines for wheel diameter:

- Larger diameter wheels allow for less rolling resistance, which results in lower pushing forces for workers.
- Larger diameter wheels make it easier to overcome obstacles.
- Heavier loads require larger diameter wheels.
- Longer distances require larger diameter wheels.

Be aware that overall cart height increases with larger diameter wheels.

Use of Cart	Wheel Diameter
Short distances, pushing by hand	7.5–10 cm (3–4 in.)
Long distances, pushing by hand	12.5–20 cm (5–8 in.)

Table 4.1 Recommended specifications for wheel diameter

Width

Narrower wheels allow for greater manoeuvrability. Narrower wheels are recommended on hard floors or flat, unpadded carpets where high manoeuvrability is required.

Wider wheels are recommended for carpets and low-friction surfaces (for example, wet flooring) where high manoeuvrability is not required; or for plush or padded carpeting where high manoeuvrability is required.

Shape

The two general shapes of wheels are crown and flat.

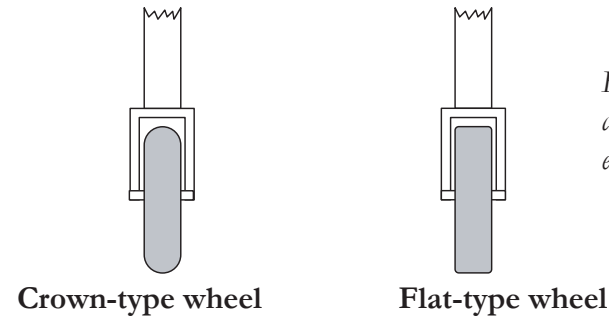

Figure 4.13 Crown-type wheels have curved edges and flat-type wheels have flat edges.

	Crown-type wheels	Flat-type wheels
Contact Surface Area	• less contact with floor	• more contact with floor
Friction	• less friction	• more friction
Manoeuvrability	• better manoeuvrability	• poorer manoeuvrability
Recommended uses	• non-carpeted floors, especially in areas requiring side-to-side manoeuvrability and sharp turns	• carpets or low-friction surfaces (for example, wet flooring) where high manoeuvrability is not required

Table 4.2 Characteristics of crown-type and flat-type wheels

Firmness (material)

Different degrees of firmness make different wheels better suited for certain applications. In general, harder wheels (for example, nylon) roll easily on hard, smooth surfaces but they are more difficult to roll over floor cracks or elevator sills. Softer wheels (for example, rubber or polyurethane) roll more easily on rough surfaces but they are harder to push on hard, smooth surfaces. Some common wheel materials and their characteristics and recommended uses are listed in Table 4.3.

Type of wheel	Characteristics	Recommended uses
Harder — Nylon or plastic (Duratron)	<ul style="list-style-type: none"> • less elastic, with less give • low-friction • non-marking • non-water absorbing 	<ul style="list-style-type: none"> • hard floors • wet environments • heavy loads
Softer — Elastomer rubber or urethane	<ul style="list-style-type: none"> • conforms to surfaces, with more give • high-friction • long-lasting • quiet • non-marking 	<ul style="list-style-type: none"> • carpets, hard floors • indoor and outdoor surfaces

Table 4.3 Wheel materials, characteristics, and recommended uses

Table 4.4 summarizes the basic options when considering wheel diameter, width, shape, and firmness. Use the pre-purchase checklist in Appendix 4 to assist you with wheel selection.

Diameter		Width		Shape		Firmness	
<i>Large</i>	<i>Small</i>	<i>Narrow</i>	<i>Wide</i>	<i>Crown</i>	<i>Flat</i>	<i>Hard</i>	<i>Soft</i>
<ul style="list-style-type: none"> • lower push force • easy to roll over obstacles 	<ul style="list-style-type: none"> • higher push force • difficult to roll over obstacles 	<ul style="list-style-type: none"> • good turning ability • low rolling friction • ideal for floors 	<ul style="list-style-type: none"> • poor turning ability • high rolling friction • ideal for carpets and wet floors 	<ul style="list-style-type: none"> • good turning ability • low rolling friction • ideal for floors 	<ul style="list-style-type: none"> • poor turning ability • high rolling friction • ideal for carpets 	<ul style="list-style-type: none"> • difficult to roll over obstacles • ideal for carpets 	<ul style="list-style-type: none"> • easy to roll over obstacles • ideal for rough surfaces and outdoors

Table 4.4 Options when considering wheel characteristics

A tire is the cushion that fits around a wheel and forms its tread. The three main types of tires are pneumatic, solid, and semi-pneumatic.

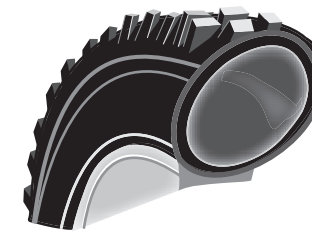

Pneumatic

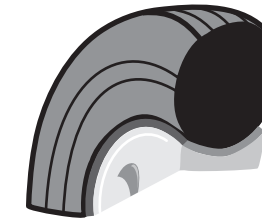

Solid

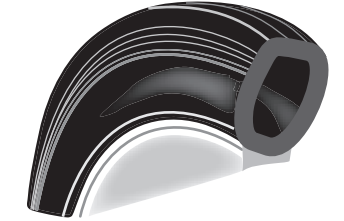

Semi-pneumatic

Figure 4.14 Pneumatic and semi-pneumatic tires have air chambers.

Pneumatic tires have an air chamber, which makes them good for traversing rough or uneven terrain or on carts used to transport fragile items. Solid tires are recommended for high load capacities and easy rollability on smooth surfaces. Semi-pneumatic tires combine an air chamber with some of the properties of a solid tire. Semi-pneumatic tires are ideal for low-speed carts.

Frequent manoeuvring of carts may require workers to use repetitive, forceful wrist motions. The position and configuration of casters and wheels on a cart influence its load weight limit and manoeuvrability. This section provides information that will help you select a set-up for each cart that will provide the optimal manoeuvrability for the task at hand.

 **swivel caster**

 **rigid caster**

 **swivel caster with lock**

Figure 4.15 The illustrations of carts in this section indicate different types of casters as shown here.

Four swivel casters, including two directional locking caster

The most versatile caster and wheel configuration is four swivel casters, including two that have directional locking at the front of the cart. Workers can lock the two front casters for straight long-distance pushing and unlock them in tighter areas where greater manoeuvrability is required.

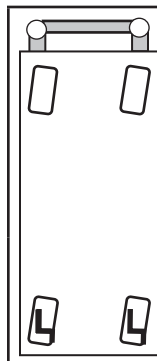
	Load weight limit:	<ul style="list-style-type: none"> multiply the load capacity of the weakest caster by 3
	Manoeuvrability:	<ul style="list-style-type: none"> excellent, especially for winding aisles or side-to-side movement
	Steering:	<ul style="list-style-type: none"> accurate for long-distance pushing easy in busy or small spaces

Four swivel casters

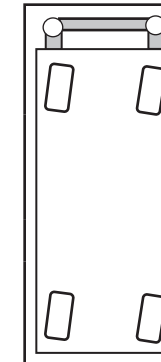
	Load weight limit:	<ul style="list-style-type: none"> multiply the load capacity of the weakest caster by 3
	Manoeuvrability:	<ul style="list-style-type: none"> excellent, especially for winding aisles or side-to-side movement
	Steering:	<ul style="list-style-type: none"> difficult for long-distance pushing and on uneven surfaces
	Other:	<ul style="list-style-type: none"> not recommended for inclines

Two swivel casters and two rigid casters

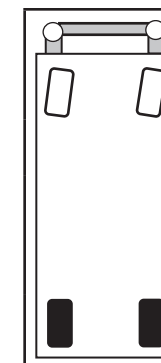
	Load weight limit:	<ul style="list-style-type: none"> multiply the load capacity of the weakest caster by 3
	Manoeuvrability:	<ul style="list-style-type: none"> good
	Steering:	<ul style="list-style-type: none"> accurate for long-distance pushing moderately easy in busy or small spaces
	Other:	<ul style="list-style-type: none"> should normally be pushed with the rigid casters leading

One swivel caster and two rigid casters

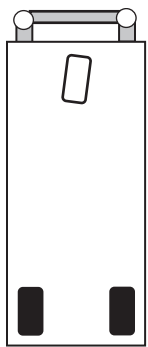
	Load weight limit:	<ul style="list-style-type: none"> multiply the load capacity of the weakest caster by 2.25 distribute the load evenly to ensure stability
	Manoeuvrability:	<ul style="list-style-type: none"> good for light loaded carts
	Steering:	<ul style="list-style-type: none"> moderately easy
	Other:	<ul style="list-style-type: none"> load must be evenly distributed to ensure stability

Three swivel casters

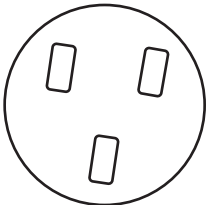
	Load weight limit:	<ul style="list-style-type: none"> multiply the load capacity of the weakest caster by 2.25 ideal for small loads
	Manoeuvrability:	<ul style="list-style-type: none"> excellent
	Steering:	<ul style="list-style-type: none"> difficult in straight lines or on uneven surfaces unsteady balance
	Other:	<ul style="list-style-type: none"> ideal for barrel dollies and small portable machines

Four rigid casters (two raised central casters, allowing central pivoting)

The central rigid casters can be replaced by wheels mounted on a central axle.

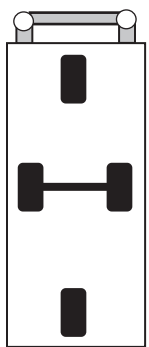
	Load weight limit:	<ul style="list-style-type: none"> multiply the load capacity of the weakest caster by 1.5 entire load may rest on the two central casters
	Manoeuvrability:	<ul style="list-style-type: none"> poor
	Steering:	<ul style="list-style-type: none"> ideal for long distances with infrequent changes of direction
	Other:	<ul style="list-style-type: none"> economical unsteady balance pivoting on the central wheels allows for easier movement across obstacles such as floor transitions or door footers the casters are subjected to shock loads if the cart is tipped, the load is unevenly distributed, or when crossing obstacles

Four swivel casters and two rigid casters (allowing central pivoting)

The central rigid casters can be replaced by wheels mounted on a central axle

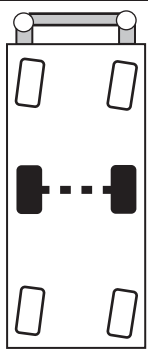
	Load weight limit:	<ul style="list-style-type: none"> multiply the load capacity of the weakest caster by 1.5
	Manoeuvrability:	<ul style="list-style-type: none"> good
	Steering:	<ul style="list-style-type: none"> easy to handle
	Other:	<ul style="list-style-type: none"> best used for very long carts designed to carry heavy loads very stable base of the cart must be strongly constructed the swivel casters are subjected to shock loads if the cart is tipped or the load is unevenly distributed

Two swivel casters and two rigid casters (allowing central pivoting)

The central rigid casters can be replaced by wheels mounted on a central axle

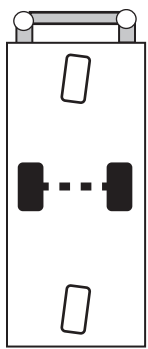
	Load weight limit:	<ul style="list-style-type: none"> multiply the load capacity of the weakest caster by 1.5 entire load rests on the two central casters
	Manoeuvrability:	<ul style="list-style-type: none"> excellent
	Steering:	<ul style="list-style-type: none"> excellent
	Other:	<ul style="list-style-type: none"> great for tight spaces the fixed casters are subjected to shock loads if the cart is heavily tipped or the load is unevenly distributed

Turning radius

Different caster and wheel positions and configurations provide different turning radiuses. Figure 4.16 contrasts the turning radiuses of two different configurations: four swivel casters versus two swivel and two rigid casters. Swivel casters are recommended for navigating cluttered hallways or tight turns.



Four swivel casters

Two swivel casters and two rigid casters under the handle

Figure 4.16 A configuration of four swivel casters provides the manoeuvrability necessary to navigate cluttered hallways or tight turns.

Load weight

The load weight of a cart is the sum of the weight of the material being transported and the weight of the cart itself. Load weight influences the amount of force that workers must exert when handling carts.

Load weight limits

By selecting the appropriate cart for a task, workers can minimize the amount of force they will need to exert for that task. Knowing a cart’s load weight limit and using the cart within that limit will further reduce the overall risk of injury. Table 4.5 specifies recommended maximum load weight limits for hand carts and trucks. Figure 4.17 shows examples of each type of cart or truck.

Type of Cart or Truck	Load Weight Limit*	
	kg	lb
two-wheeled hand cart	114	250
three-wheeled hand cart	227	500
four-wheeled hand cart	227	500
hand pallet truck	682	1500

Table 4.5 Recommended maximum load weight limits for hand carts and hand trucks

* Load weight limit = cart weight + material weight

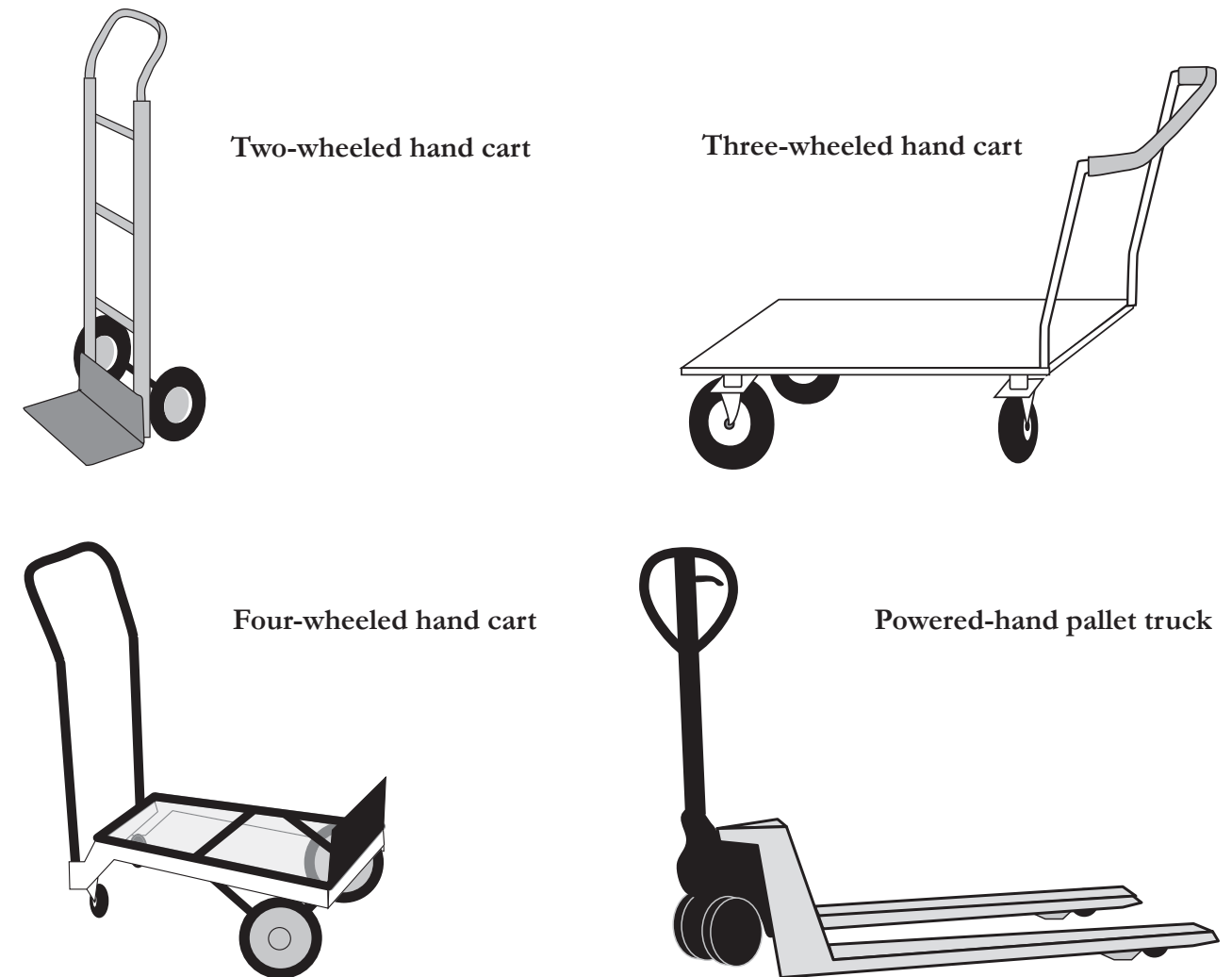

Figure 4.17 Selecting the appropriate hand cart or truck for a specific task can help reduce the risk of MSI.

Load capacity

The load capacity is the amount of weight that a caster can safely support. Knowing the load capacity of casters allows you to:

- choose a cart for a specific load
- determine the load weight limit of an existing cart so it can be used safely

See Appendix 5 for sample calculations using load weight and load capacity.

Consider the following when deciding if a cart should have a braking system:

- Wheel brakes should be locked and unlocked by foot rather than by hand. This makes access to the brakes easier and will encourage workers to use them, and will help minimize awkward postures.
- Carts with a capacity of more than 500 kg (1100 lb.) should have hand-activated braking systems.
- When transporting carts on inclines, workers can use hand brakes to keep the speed down. Hand brakes reduce the force needed to slow down the cart and provide workers with greater control of the cart.

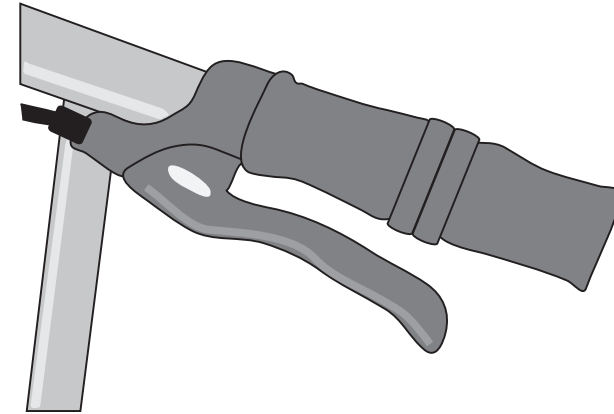

Figure 4.18 Hand brakes provide workers with greater control over the speed of a cart.

Workers can use mechanical devices such as motorized push-pullers to pull carts that exceed the load weight limit, or several carts together instead of pulling them manually one at a time. This helps reduce the amount of force needed to complete the MMH task and reduces the risk associated with highly repetitive tasks.

Motorized push-pullers can resolve visibility problems associated with tall carts because they allow workers to stand in front of the carts and use the machine to pull them. Motorized push-pullers are also an option in situations where heavy carts cannot be modified.

Motorized push-pullers are not suitable for all facilities. They require extra hallway space and steering room, and purchase costs may be prohibitive.

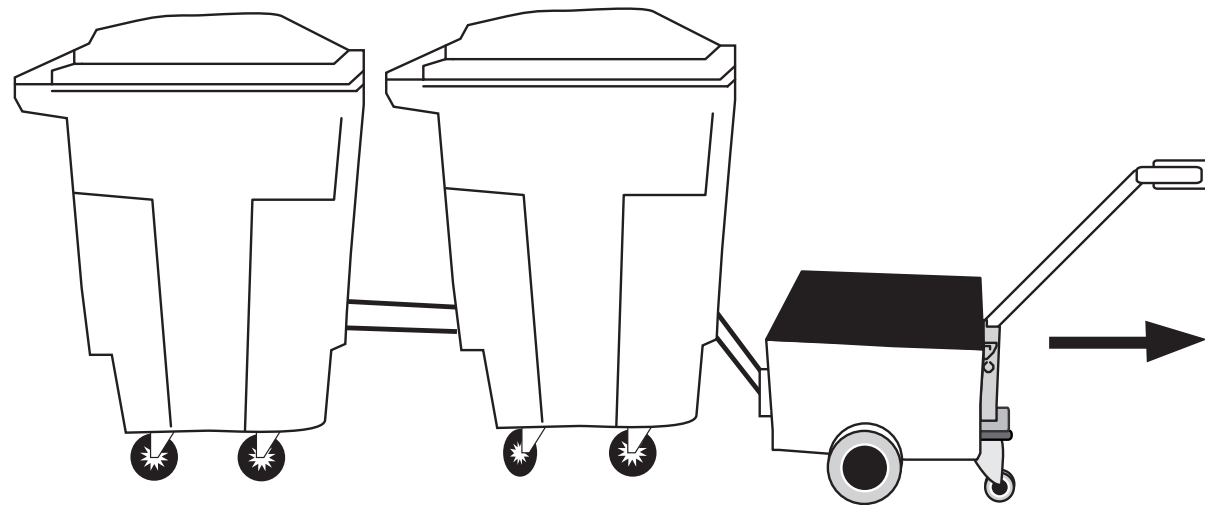
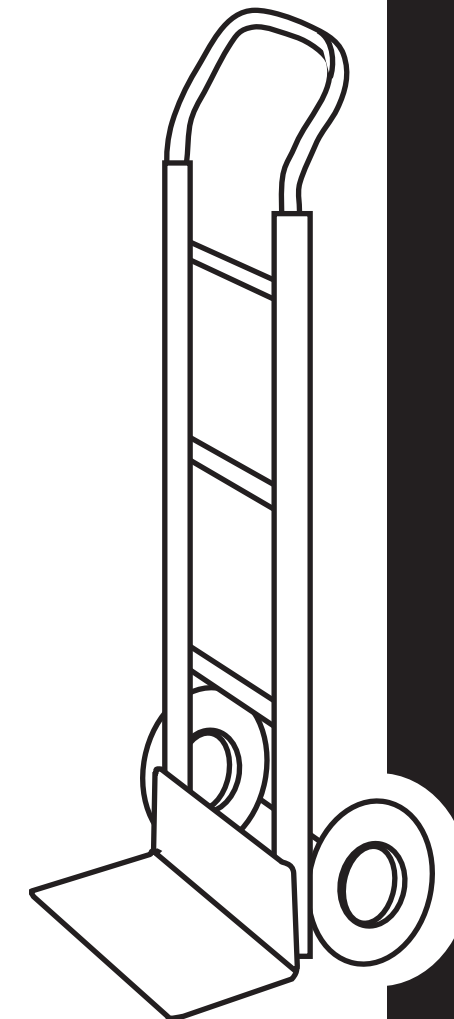

Figure 4.19 Workers can use motorized push-pullers to move several carts at once



5

Environmental Conditions

Conditions in the work environment may influence ergonomic risk factors directly or indirectly, which can increase the risk of injury. This section outlines three environmental factors that may influence the risk of MSI for workers who are handling carts:

- Floors and ground covering
- Hallways and doors
- Inclines

Consider what types of surfaces workers will be handling carts on. Wheels on carts must be large enough to negotiate floor conditions such as cracks in the floor, tracks, mouldings, gaps at elevator doors, transitions between flooring surfaces, and any other unforeseen obstacles.

Also consider if carts will be handled outdoors and if weather conditions will affect handling. Careful selection of wheel size, shape, and firmness, as well as the configuration of wheels and casters will give the best results where unusual conditions exist (for example, moisture, extreme heat or cold, and exposure to substances such as chemicals, blood, fats, oils, or salt).

Consider these guidelines for minimizing the impact of floors and ground covering on the risk of MSI:

- Keep floors clean and free of debris that may interfere with wheels. For example, in shipping and receiving, packing materials and tape can stick to wheels, making them harder to roll.
- Fill in cracks in the floor so wheels will roll smoothly.
- Design transitions between different floor types (for example, between carpet and tile) so they are smooth, with minimal gaps or changes in height.

Moving carts safely through hallways and doors depends on adequate clearance, good manoeuvrability, and clear visibility. Consider the following guidelines for hallways and doors to reduce the risk of injury:

- Ensure that hallways or passages in which carts will be used meet the recommended minimum width of 122 cm (48 in.).
- Allow “swing doors” at cart destinations to remain open.
- Install automatic doors that are activated by motion detectors or push buttons. This will eliminate the awkward postures and forceful exertion that occur when workers hold doors open to move carts through doorways.
- Remove raised doorsills or provide an incline overtop.

Slope, rise, and run

Slope is defined as the ratio of vertical distance (rise) to horizontal distance (run) so a greater number means a greater incline. Ideally, the incline should have a slope less than 1:20 (for example, 1:25, 1:30, etc.). The maximum rise and minimum run of a ramp depends on the slope (see Table 5.1).

Ramp

A ramp is any inclined plane that has a slope greater than 1:20 (for example 1:15, 1:10, etc.). Avoid transporting carts up and down ramps if possible. Minimizing or eliminating the use of ramps will reduce the forces required to move carts. If workers must use a ramp, it should have the most gradual slope possible. Table 5.1 describes guidelines for designing ramps. These comply with the BC Building Code and ADAAG (2002) guidelines.

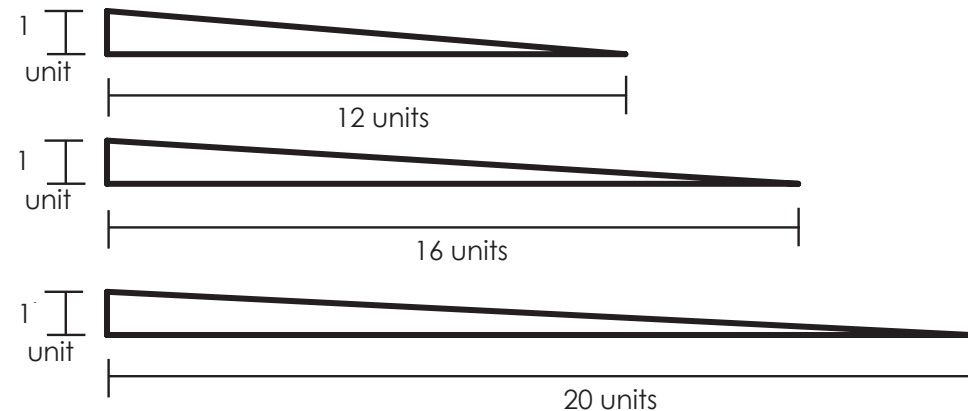

Figure 5.1 Inclines with slope ratios of 1:12, 1:16, and 1:20.

Slope	Maximum Rise	Minimum Run
1:12 to < 1:16	76 cm (30 in.)	9 m (30 ft.)
1:16 to < 1:20	76 cm (30 in.)	12 m (40 ft.)

Table 5.1 Recommended maximum rises and minimum runs for slopes (from BC Building Code, Article 3.8.3.3)

Cross slope

If a worker is required to move across a ramp, the cross slope of the ramp should be no greater than 1:50.

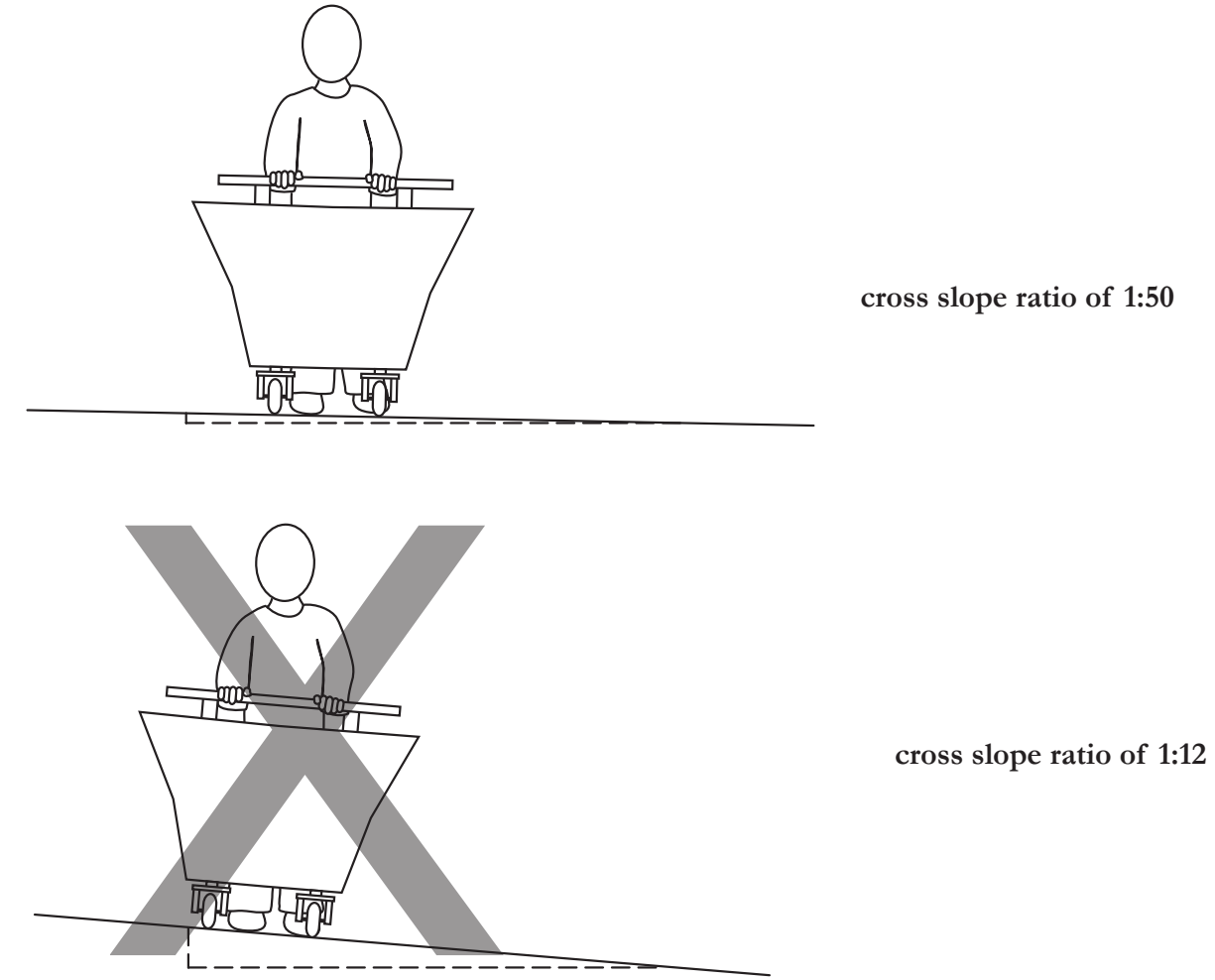

Figure 5.2 When moving across a ramp, a cross slope ratio of no more than 1:50 is acceptable.

Landings

Ramps should have level landings at the top and bottom. Landings should have the following specifications:

- The landing should be at least as wide as the ramp run leading to it.
- The landing should be at least 152.5 cm (60 in.) long.
- If the ramp changes direction at the landing, the landing should be at least 152.5 x 152.5 cm (60 x 60 in.).

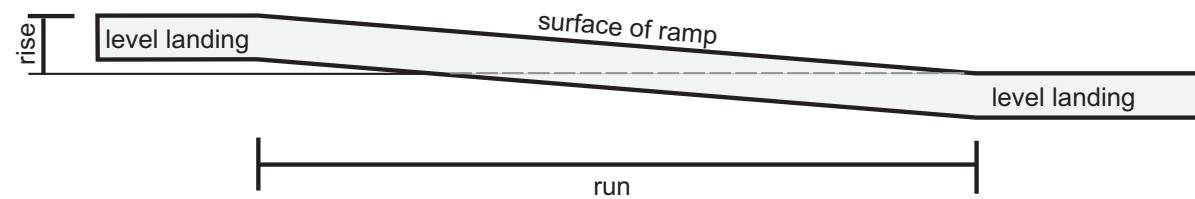
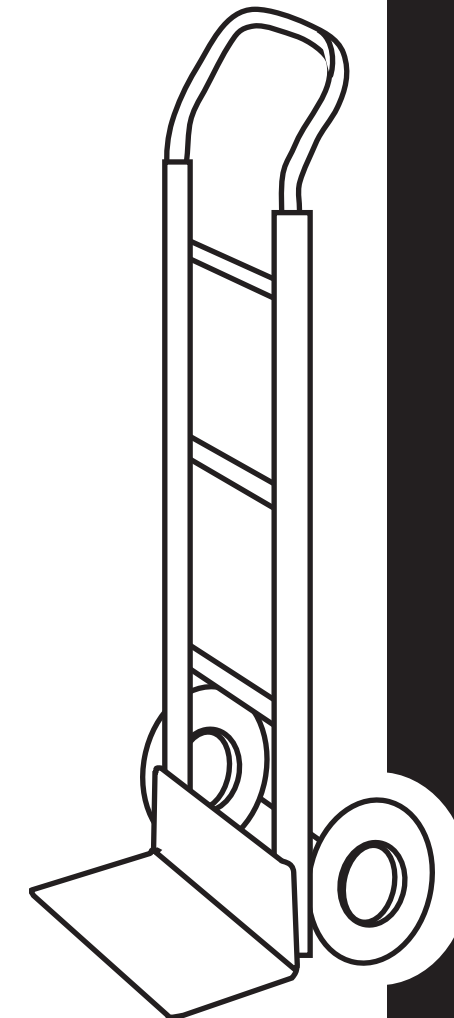

Figure 5.3 A ramp with level landings at the top and bottom.

Outdoor ramps

Outdoor ramps such as those on loading docks should be coated or covered with slip-resistant material to improve stability when moving carts in wet conditions. Ideally, the ramp should be under a roof to prevent exposure to moisture.



6

Education and Training

This part provides information on worker education and training on MSI prevention related to MMH and using carts. It includes the following sections:

- Sample education module for MSI prevention for workers using carts
- Guidelines for occupational health and safety training

This sample education module is for anyone who will be affected by the implementation of carts in a facility. It is recommended that the following seven components be delivered in several sessions to allow participants enough time to absorb the information. For more information on effective health and safety training, see “Guidelines for occupational health and safety training,” on page 72.

1. Introduction and goals

- reasons for training
- what participants should know by the end of the course or session
- WorkSafeBC requirements
- facility-specific MSI prevention policies and procedures

2. What is musculoskeletal injury (MSI)?

- common types of MSI
- signs and symptoms of MSI
- health effects of MSI
- progression of a typical MSI

3. Risk factors for MSI

- general risk factors
- cart-specific risk factors
- identifying risk factors

4. Risk assessment

- assessing work areas, equipment, loads, and tasks

5. Control measures

- hierarchy of control measures (engineering controls, administrative controls, and personal protective equipment)
- general control measures (for example, workspace layout, work organization, and rest breaks)
- cart-specific control measures

6. Body mechanics

- safe posture
- lifting, lowering, and carrying
- pushing and pulling
- stretching and relaxation
- personal factors
- practice sessions

7. Techniques and procedures

- selecting appropriate carts for specific tasks
- demonstrations on how to use specific carts
- safe pushing and pulling methods
- procedure for out-of-service carts
- maintenance plan

Suggested handouts

- MSI prevention program for the facility
- MSI prevention policies and procedures for the facility (for example, safe work procedures)
- stretching exercises

Follow these basic guidelines for effective occupational health and safety training:

1. Assess learning needs.
2. Develop a training program with occupational health and safety specialists and front-line workers. Ensure that the training is:
 - specific to the tasks encountered by the workers
 - specific to the work history of the workers
 - highly interactive and based on adult learning principles
 - tailored to the needs of each audience of workers
3. Provide resources and encourage a high level of worker participation.
4. Train workers, supervisors, and support staff.
5. Ensure that the person delivering the training program is familiar with the occupational risk factors for MSI and the specific tasks required by the job.
6. Ensure that supervisors and other staff reinforce safe practices regularly.
7. Update workers, supervisors, and support staff on a regular basis.

Note: OHSAH ergonomists may be available for consultation and assistance with setting up a “train-the-trainer” program in which peers teach peers.

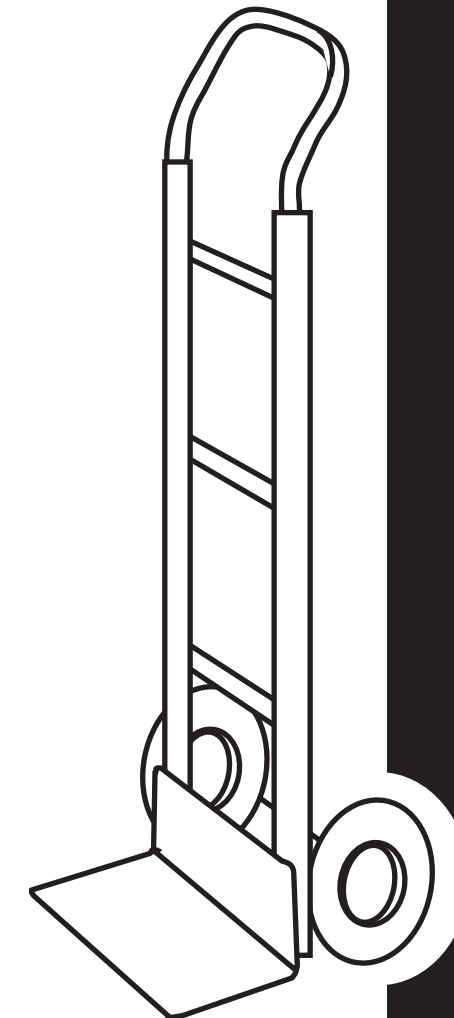

7

Implementation and Evaluation

This part provides information on the risk management process as well as implementing and evaluating a control measure, in this case, the use of carts for MMH. It includes the following sections:

- Pre-implementation risk identification and assessment
- Implementation of the control measures
- Post-implementation evaluation

The purpose of risk identification is to identify the locations and tasks in the facility that pose a risk of MSI to workers. Once risks have been identified for a specific task, they need to be assessed to determine the degree of risk present and what types of control measures should be implemented. Evaluating the success of a control measure is important and can be a simple process. Evaluations allow you to see what works and what does not. Conducting a pre-implementation risk identification and assessment helps clarify what you are trying to accomplish and establishes current risk levels. Knowing current risk levels will make it easier for you to evaluate the effectiveness of using carts as a control measure.

Step 1. Determine what you are trying to identify and assess

What are the areas of concern? Which MMH tasks do workers have difficulty with?

Step 2. Identify potential risk factors for MSI

Does it appear that risk factors are present?

Use one or more of the following five tools to evaluate the current risk of MSI.

Tool 1: Task descriptions

Compile a descriptive list of all the tasks that are required to perform a job, including the MMH tasks. What does the worker do in this job? A task list will help to ensure that all tasks are considered and that risk identification for individual MMH tasks is viewed within the context of the entire job. A task description should include, at minimum, a list of tasks performed in the job and the typical frequency and duration of the tasks.

Tool 2: Signs and symptoms survey

A signs and symptoms survey (see Appendix 1) helps determine if workers are currently experiencing signs and symptoms of MSI. Make copies and survey workers during the risk identification stage, before the use of carts is implemented. Allowing workers to complete the survey anonymously will likely increase the return rate.

Tool 3: Interviews and focus groups

Interviews allow for open discussion and can provide more information than surveys. Informal or formal interviews with workers can be a useful way to gather information about jobs and specific tasks that may require assessment. You may conduct interviews with individual workers or small groups.

- What do workers feel are priorities with respect to MMH tasks?
- Which tasks do workers feel could be made easier with the use of a cart?
- How will a cart change their work?

Let workers know that you are evaluating the work site and work equipment, not their performance. Maintaining a level of confidentiality may improve the level of discussion (for example, do not record names with concerns or suggestions).

Tool 4: Incident reports

Analyze incident report forms, going back one to three years. How often have incidents related to MMH occurred in the past? What body parts were affected? What was the nature of the injury? Use this tool in combination with one of the other two tools. Workers may have signs or symptoms even though few incidents are, or have been, reported.

Tool 5: Risk identification checklists

Observe workers performing the MMH tasks, noting details such as body posture, repetitive motion, and forceful exertion. Use a risk identification checklist (see Appendix 2) to identify potential risk factors for MSI associated with using carts.

Step 3. Investigate and assess the current risk of MSI

There are four elements to consider when assessing significant risks:

- magnitude of each risk factor (how much?)
- frequency of exposure to each risk factor (how often?)
- duration of exposure to each risk factor (how long?)
- presence of multiple risk factors

After you have identified the potential risk factors, the next step is to implement the control measure (using carts). As part of the implementation process, you should create a working group and develop an implementation guideline.

Create a working group

Create a working group to oversee the implementation process. Include the following individuals:

- managers
- department workers
- maintenance workers
- a health and safety professional (for example, an ergonomist, occupational health and safety consultant, MSI prevention advisor, occupational therapist, physiotherapist, or union safety steward)

Develop an implementation guideline

Discuss potential control measures and come to a consensus about which measures should be implemented. In this case, discussion will focus on the types of carts that should be used and which tasks they should be used for. Write down all the control measures that the working group wants to implement (see the implementation guideline in Appendix 7). Include reasons for decisions, actual dates for implementation, and names of individuals who will oversee the implementation process.

Once your implementation guideline is finalized, give each working group participant a copy. Post a copy in a common area of the department that will be affected by the implementation and check off control measures as they are implemented. By doing this you will ensure that those affected will be informed and the working group will be held accountable for implementation.

Conducting evaluations after control measures are implemented helps determine the effectiveness and efficiency of the control measures.

Step 1. Identify potential risk factors for MSI

Does it appear that the risk factors you intended to address have been eliminated or minimized? Observe workers using carts, noting details such as cart selection, body posture, and repetitive motion.

Step 2. Evaluate whether the risk of MSI has decreased

Has the risk of MSI decreased as a result of using carts? Your evaluation should:

- re-evaluate the risk factors that you intended to eliminate or minimize
- determine whether the control measure has created new risk factors

Use one or more of the following three tools to evaluate whether the risk of MSI has decreased.

Tool 1: Signs and symptoms survey

Survey workers three to six months after the carts have been put into use. Signs and symptoms should decrease with the new control measure.

Tool 2: Interviews and focus groups

Schedule meetings with workers or small groups of workers. Let workers know that you are evaluating the control measure, not their performance. Get their perceptions as to whether the control measure has been an improvement and whether any new issues have arisen.

Tool 3: Incident reports

Analyze incident report forms, comparing reports from one to three years before any carts were implemented with reports from one to three years afterwards. Did reported incidents decrease after changes were made? Use this analysis in combination with one of the other two tools.

Step 3. Compile the results

Document and circulate your evaluation results for future reference.

Step 4. Understand the results

Determine whether the carts were helpful, and whether the new procedures and new equipment are being used. If the new carts were not effective, review the risk factors and develop new solutions. Gather the working group together without delay and try another control measure or modify the carts currently in place.

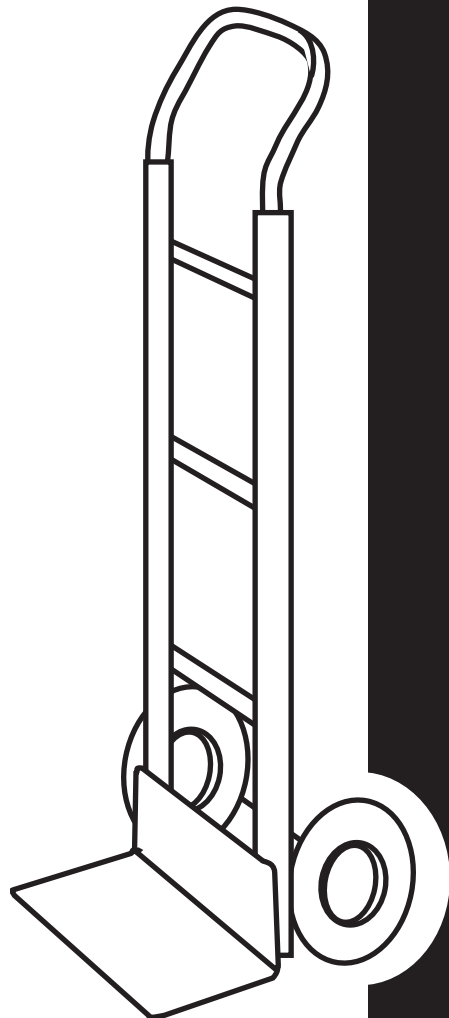

Appendices

These appendices provide additional information and resources that will help you improve health and safety for workers using carts.

- Appendix 1: Signs and symptoms survey
- Appendix 2: Risk factor identification checklist
- Appendix 3: WorkSafeBC ergonomics requirements
- Appendix 4: Pre-purchase checklists and flow charts
- Appendix 5: Sample calculations using load weight and load capacity
- Appendix 6: Cart identification form (existing carts)
- Appendix 7: Implementation guideline
- Appendix 8: Stretching routine
- Appendix 9: References

Date ____/____/____/ Name:_____

Facility:_____ Department #:_____ Job name:_____

Shift hours worked/week:_____ Time on THIS job:_____years____months

Your responses will remain confidential

Other jobs you have done in the last year (for more than 2 weeks)

Facility:_____	Facility:_____
Department #:_____	Department #:_____
Job Name:_____	Job Name:_____
Time on THIS job:___ years ___ months	Time on THIS job:___ years ___ months

(If more than 2 jobs, include those you worked on the most)

Have you had any pain or discomfort during the last year? Yes No
 (If NO, stop here)

If YES, carefully shade in area of the drawing which bothers you the MOST. (Complete a separate page for each area that bothers you)

Circle Area:

- | | | | |
|---------|------------|---------------|------------|
| Neck | Shoulder | Elbow/Forearm | Hand/Wrist |
| Fingers | Upper Back | Low Back | Thigh/Knee |
| Low Leg | Ankle/Foot | | |

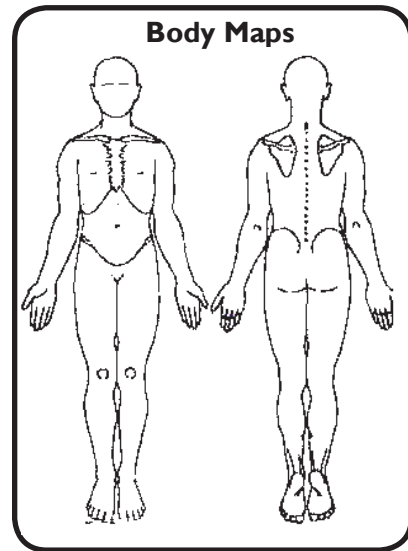

1. Circle the word(s) that best describe your problem.

- | | | |
|----------------|-------------------|----------|
| Aching | Numbness (asleep) | Tingling |
| Burning | Pain | Weakness |
| Cramping | Swelling | Other |
| Loss of Colour | Stiffness | |

2. When did you first notice the problem? _____(month) _____(year)

3. How long does each episode last? (Mark an X along the line)

1 hour 1 day 1 week 1 month 6 months

4. How many separate episodes have you had in the last year?

5. What do you think caused the problem?

6. Have you had this problem in the last 7 days? ____ Yes ____ No

7. How would you rate this problem? (Mark and X on the line)

a. NOW

None _____ Unbearable

b. When it is the WORST

None _____ Unbearable

8. Have you had medical treatment for this problem? Yes No

8a. If NO, why not? _____

8b. If YES, where did you receive treatment?

1. Facility medical Times in past year _____

2. Personal doctor Times in past year _____

3. Other Times in past year _____

8c. Did treatment help? Yes No

9. How much time have you lost in the last year because of this problem?

10. How many days in the last year were you on restricted or light duty because of this problem? _____ days

11. Please comment on what you think would improve your symptoms.

Use this checklist to identify potential risk factors for MSI associated with using carts. Before filling out the checklist, familiarize yourself with the tasks being performed. Checking “Yes” for items indicates that potential risk factors may be present and further analysis is required. For help determining control measures for the identified risk factors, refer to Parts 3 and 4.

Potential risk factor	Yes	No
<i>Force</i>		
Does the cart require a lot of effort to get moving?		
Does the cart require a lot of effort to keep moving?		
Does the cart require a lot of effort to steer or manoeuvre?		
Are workers loading or unloading materials heavier than 23 kg (50 lbs.)?		
Is the load unstable or prone to shifting while the cart is moving?		
Are there raised doorsills, floor transitions, cracks, or other obstacles on the ground along the path of the cart?		
Does the cart have wheels less than 7.5 cm (3 in.) in diameter?		
Do workers push the cart over deep pile, padded carpet, or other soft surfaces?		
Do workers push the cart up or down inclines?		
Are there inclines that have a grade steeper than 1:20?		
Are there lateral slopes that workers must push the cart along?		
Is the cart more than 1.3 m (51 in.) long or 1 m (39 in.) wide?		
<i>Repetition</i>		
Do workers spend most of their workdays pushing or pulling carts?		

Potential risk factor	Yes	No
<i>Awkward posture</i>		
Does the cart have shelves below knee height?		
Does the cart have shelves above shoulder height?		
Is it difficult to see over the loaded cart when pushing from behind?		
Do workers pull carts rather than push them?		
Are the materials carried on the cart often large or bulky?		
Does the cart lack handles?		
Are the cart handles below waist height or above shoulder height?		
<i>Static posture</i>		
Do workers push carts over distances greater than 60 m (197 ft.)?		
<i>Contact stress</i>		
Do the cart handles lack padding?		
Do the cart handles have sharp or squared edges?		
Are the cart handles wider than the cart?		

Under the authority of the Workers Compensation Act, WorkSafeBC has adopted and implemented ergonomics requirements, detailed in the Occupational Health and Safety Regulation, Sections 4.46 to 4.53 (reprinted in this appendix). These requirements represent the minimum standards that must be complied with at workplaces that fall under WorkSafeBC jurisdiction and within the scope of the Act.

Ergonomics (MSI) requirements

The purpose of sections 4.46 to 4.53 is to eliminate or, if that is not practicable, minimize the risk of musculoskeletal injury to workers.

Note: WorkSafeBC provides publications to assist with implementing the Ergonomics (MSI) Requirements. Preventing Musculoskeletal Injury (MSI): A Guide for Employers and Joint Committees provides a seven-step process to assist with the application of the ergonomics requirements along with procedures to investigate incidents of MSI and a table of common control measures. Understanding the Risks of Musculoskeletal Injury (MSI) is intended to help employers with the requirements of section 4.51(1) to educate workers in risk identification, signs and symptoms of MSI, and their potential health effects.

[Note added September 25, 2001]

4.46 Definition

In sections 4.47 to 4.53 (the Ergonomics (MSI) Requirements) “musculoskeletal injury” or “MSI” means an injury or disorder of the muscles, tendons, ligaments, joints, nerves, blood vessels or related soft tissue including a sprain, strain and inflammation, that may be caused or aggravated by work.

4.47 Risk identification

The employer must identify factors in the workplace that may expose workers to a risk of musculoskeletal injury (MSI).

4.48 Risk assessment

When factors that may expose workers to a risk of MSI have been identified, the employer must ensure that the risk to workers is assessed.

4.49 Risk factors

The following factors must be considered, where applicable, in the identification and assessment of the risk of MSI:

- (a) the physical demands of work activities, including
 - i. force required,
 - ii. repetition,
 - iii. duration,
 - iv. work postures, and
 - v. local contact stresses;
- (b) aspects of the layout and condition of the workplace or workstation, including
 - i. working reaches,
 - ii. working heights,
 - iii. seating, and
 - iv. floor surfaces;
- (c) the characteristics of objects handled, including
 - i. size and shape,
 - ii. load condition and weight distribution, and
 - iii. container, tool and equipment handles;
- (d) the environmental conditions, including cold temperature;
- (e) the following characteristics of the organization of work:
 - i. work-recovery cycles;
 - ii. task variability;
 - iii. work rate.

4.50 Risk control

- (1) The employer must eliminate or, if that is not practicable, minimize the risk of MSI to workers.
- (2) Personal protective equipment may only be used as a substitute for engineering or administrative controls if it is used in circumstances in which those controls are not practicable.
- (3) The employer must, without delay, implement interim control measures when the introduction of permanent control measures will be delayed.

4.51 Education and training

- (1) The employer must ensure that a worker who may be exposed to a risk of MSI is educated in risk identification related to the work, including the recognition of early signs and symptoms of MSIs and their potential health effects.
- (2) The employer must ensure that a worker to be assigned to work which requires specific measures to control the risk of MSI is trained in the use of those measures, including, where applicable, work procedures, mechanical aids and personal protective equipment.

4.52 Evaluation

- (1) The employer must monitor the effectiveness of the measures taken to comply with the Ergonomics (MSI) Requirements and ensure they are reviewed at least annually.
- (2) When the monitoring required by subsection (1) identifies deficiencies, they must be corrected without undue delay.

4.53 Consultation

- (1) The employer must consult with the joint committee or the worker health and safety representative, as applicable, with respect to the following when they are required by the Ergonomics (MSI) Requirements:
 - (a) risk identification, assessment and control;
 - (b) the content and provision of worker education and training;
 - (c) the evaluation of the compliance measures taken.
- (2) The employer must, when performing a risk assessment, consult with
 - (a) workers with signs or symptoms of MSI, and
 - (b) a representative sample of the workers who are required to carry out the work being assessed.

Use this set of checklists and flow charts for each task that requires a cart, to help identify your needs so you can make a more informed decision when purchasing a cart. It is suggested that completed checklists be brought to your facility buyer and the manufacturer so they can assist you in selecting the ideal cart.

Task: _____

Materials transported: _____

Completed by: _____

Date: _____

Step 1: Checklists

Complete the following checklists. For the questions in sections B–E, consider what is required **most** of the time.

A. Load weight, load capacity, and size

1. What will the maximum load weight be? (Load weight is the combined weight of the cart and the materials being transported.)

Material weight _____ + Cart weight _____ = Load weight _____ (kg lb. *circle one*)

2. What will the maximum load capacity be? (Load capacity of each caster = Load weight ÷ Number of casters)

Load capacity _____ (kg lb. *circle one*) = (load weight _____ x 1.25) ÷ number of casters _____

Is the load capacity greater than 113 kg (250 lb.)?

- yes → If yes, bearings are recommended.
- no

3. What will the maximum load size be?
width _____ length _____ height _____

B. Wheels and casters

1. What kind of surface will the cart travel on? (*Check all that apply.*)

- carpet
- concrete
- linoleum
- tile
- polyurethane
- metal
- wet floor
- other _____

2. What obstacles, hazards, or floor conditions may be encountered? (*Check all that apply.*)

- none
- gap between elevator and floor
- raised door frames or moulding
- puddles
- wet floor
- inclines → If inclines are encountered, consider brakes.
- cracks

- floor strips
- confined spaces
- busy pedestrian traffic
- oil, grease, or chemicals
- floor debris or grills on the floor

3. How often is turning required?

- rarely (<10% of travel)
- occasionally (10 to 30% of travel)
- frequently (31 to 60% of travel)
- constantly (>60% of travel)

4. Does the cart path include the following?

- long straight runs
- confined areas

5. How far will the cart travel?

Approximate distance _____ (m ft. *circle one*) per (load hour day *circle one*)

C. Storage on cart

1. Are special shelves or hooks required?

- no
- yes

If yes, describe. _____

D. Handles

1. How will workers handle the cart?

- mostly push
- mostly pull
- equal amounts push and pull

2. How tall are cart operators? (*Check all that apply.*)

- < 152 cm (5 ft.)
- 152–168 cm (5 ft.–5 ft. 6 in.)
- 168–183 cm (5 ft. 6 in.–6 ft.)
- > 183 cm (6 ft.)

Handles should not require or encourage workers to have hands, fingers, or arms protruding to the side of the equipment.

E. Washing

1. How will workers wash the cart?

- water cleaning
- no water cleaning

2. How often will workers wash the cart?

- daily
- weekly
- every two weeks
- monthly

Cart checklist

Criteria	Yes	No
1. Does the supplier include routine maintenance instructions? If "Yes," are they easy to follow?		
2. Does the supplier include preventive maintenance program instructions?		
3. Does the supplier offer training and in-services regarding maintenance? If "Yes," are they easy to follow?		
4. Does the supplier identify a contact person for concerns?		
5. Can servicing be completed in-house?		
6. Are spare parts readily available from the supplier?		
7. Is the equipment easy to service and maintain?		
8. Is the equipment safe and stable?		
9. Does the supplier offer any after-sale services?		

Step 2: Flow charts

Use the following flow charts to help determine the appropriate characteristics for your cart. Start at the top of each flow chart and select the most appropriate item. Move down through each level of the flow chart until you have selected one item from the bottom level.

A. Firmness of Wheel

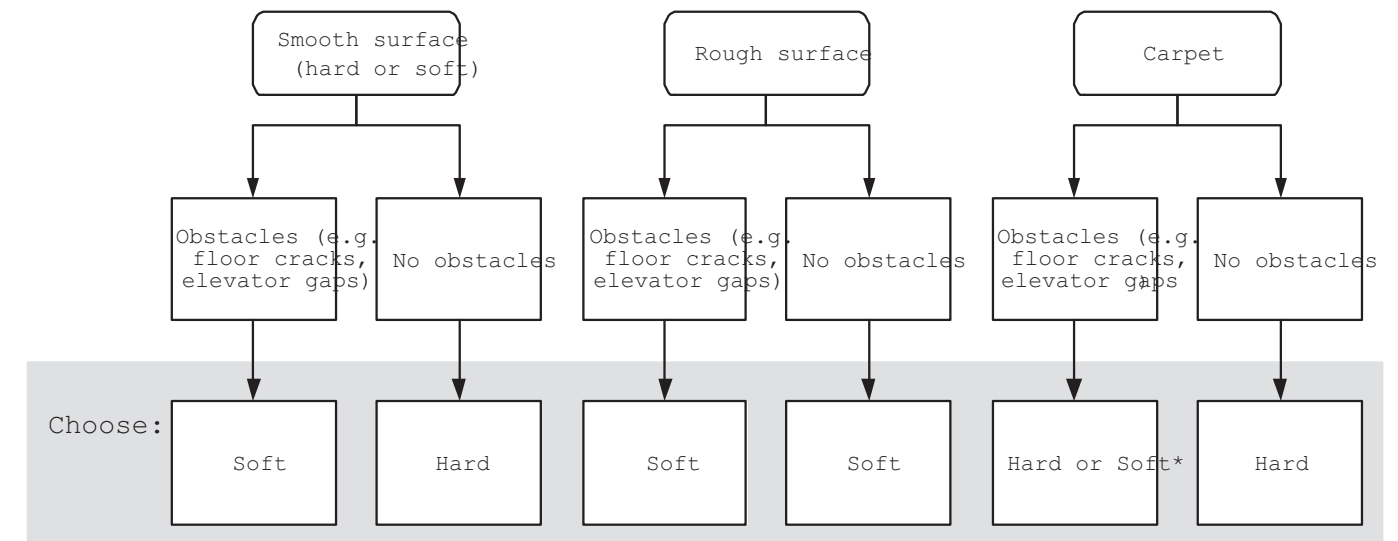

*Hard: If more time is spent carpet than overcoming obstacle or if carpet is thick.
Soft: If more time is spent overcoming obstacles than on carpet.

B. Diameter of Wheel

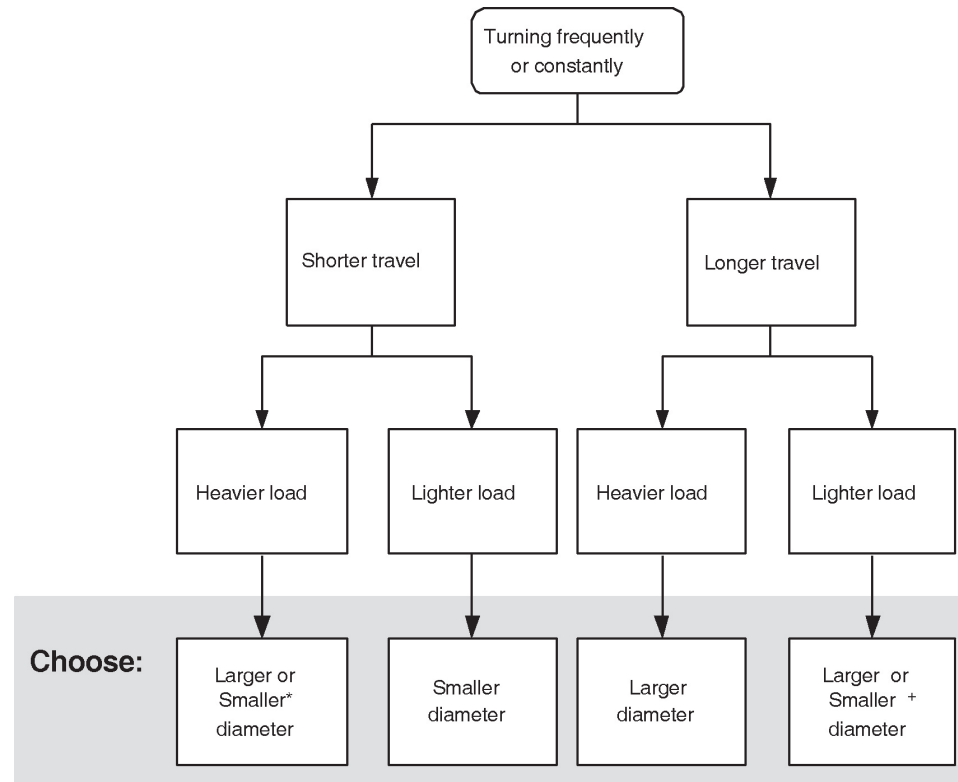

*Larger: If load is extremely heavy
Smaller: If turning is essential or difficult.

+Larger: If turning is not essential or travel is exceptionally long.
Smaller: If turning is essential or difficult.

Larger = 12.5 to 20 cm (5 to 8 in.)
Smaller = 7.5 to 10 cm (3 to 4 in.)

B. Diameter of Wheel

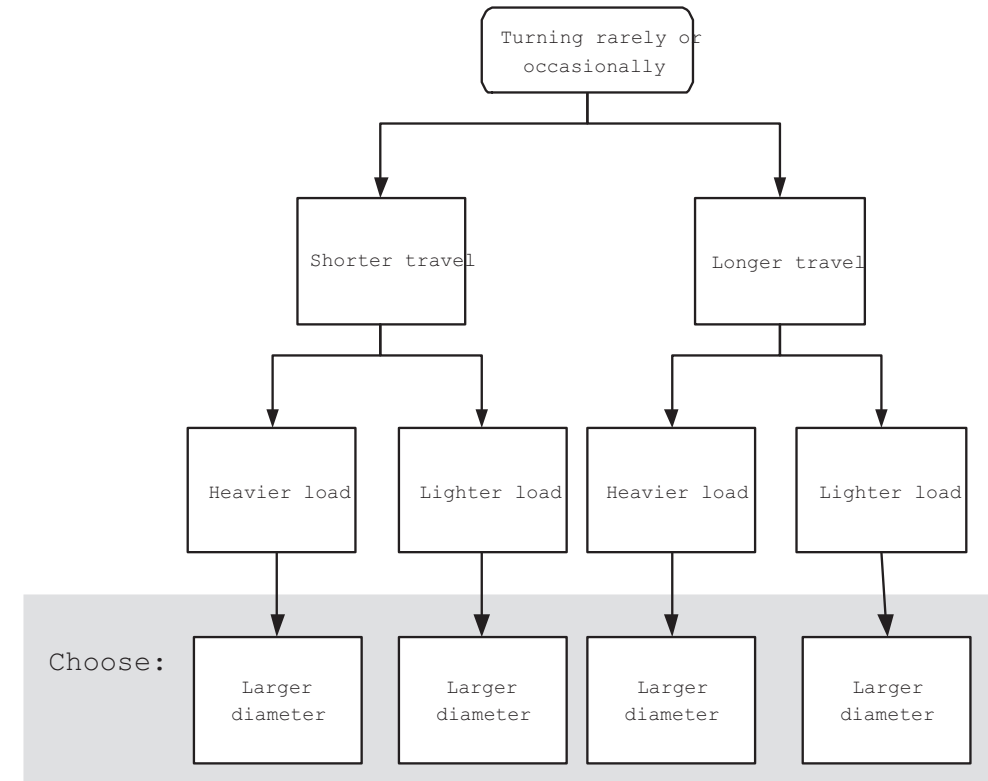

Larger = 12.5 to 20 cm (5 to 8 in.)
Smaller = 7.5 to 10 cm (3 to 4 in.)

C. Width of Wheels

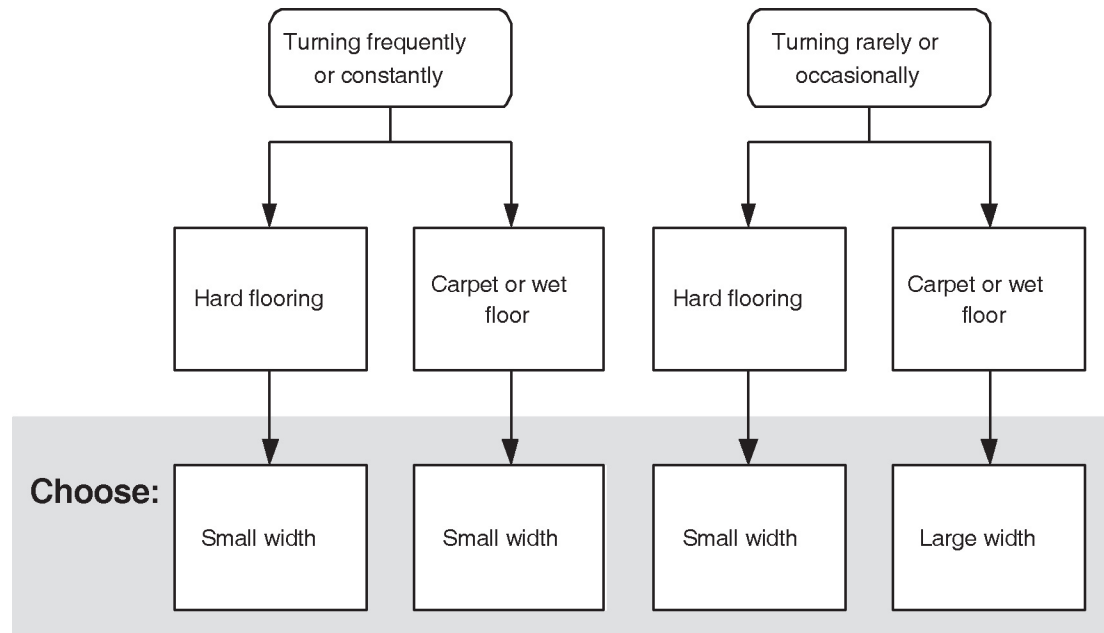

D. Wheel and Caster Configuration

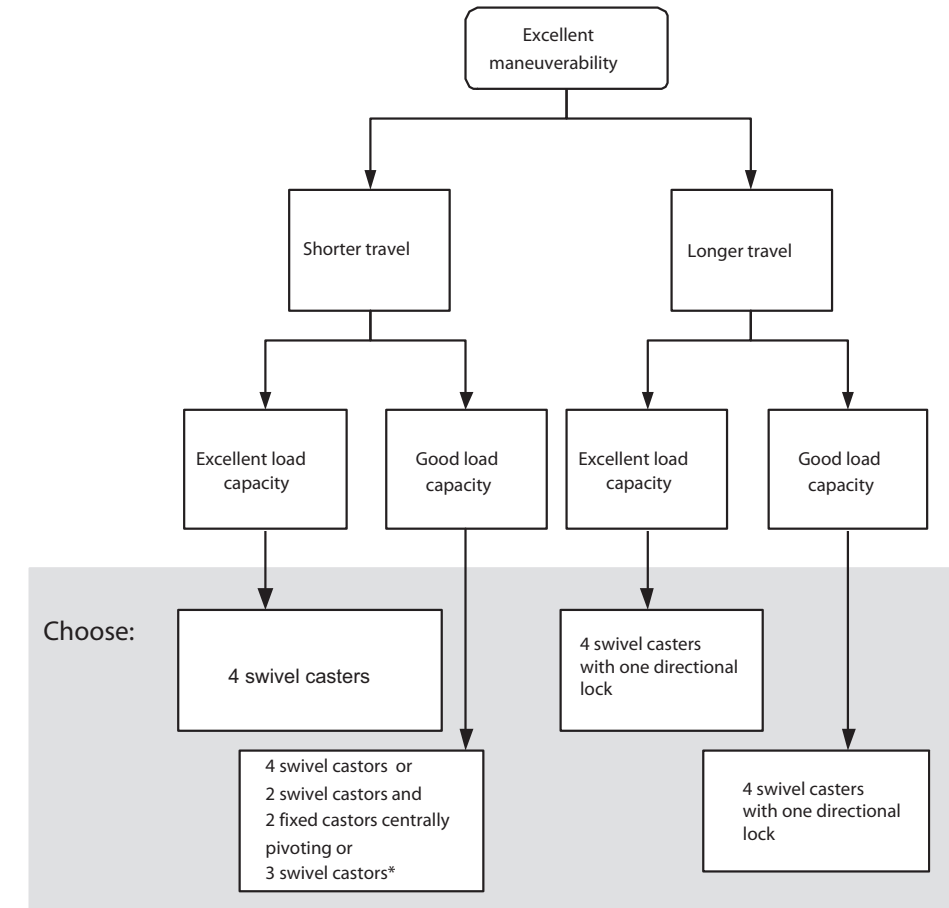

*3 swivel castors: ideal for barrel dollies and small portable machines only

D. Wheel and Caster Configuration

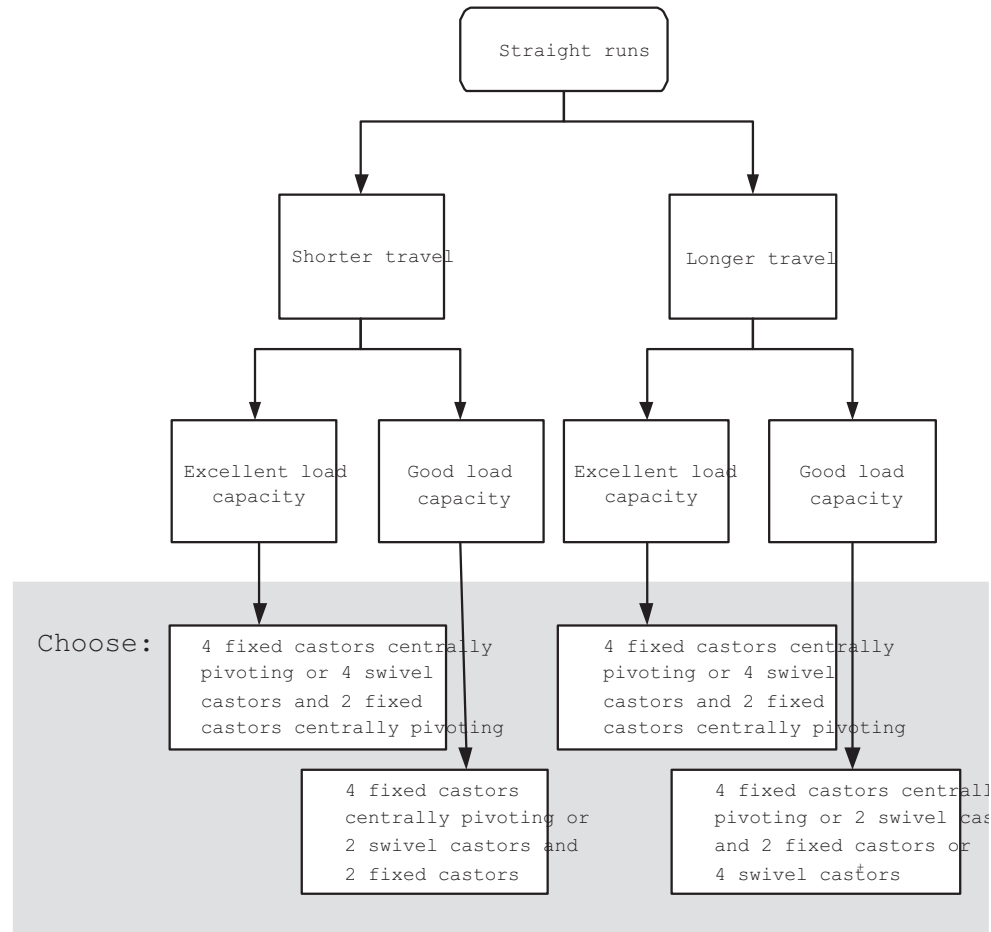

*4 swivel castors: ideal if two castors have directional locks

The basic relationship between a cart’s load weight and the load capacity of each of its casters is as follows:

$$\text{Load weight} \div \text{Number of casters} = \text{Load capacity of each caster}$$

Determining the required capacity of casters for a new cart

1. Consider the load that will be transported and establish the load weight.

$$\text{Material weight} + \text{Cart weight} = \text{Load weight}$$

2. Calculate the load capacity of the required casters.

$$\text{Load weight} \div \text{Number of casters} = \text{Load capacity of each caster}$$

Recommendation: As an extra precaution, select casters with a load capacity greater than the calculated load weight. For most situations, build in a safety factor of at least 25% (multiply the load weight by 1.25). This will account for any environmental changes that may alter the capacity of the casters. For example, when travelling on uneven ground only three out of the four wheels may be bearing most of the weight.

Example: Calculating the required load capacity of casters for a new cart

Material weight = 120 kg

Cart weight = 40 kg

Number of casters = 4

Use: Uneven ground

Safety factor: Assume that the load weight is 1.25 times greater than it actually is (25% safety factor).



1. Determine the load weight.

Material weight + Cart weight = Load weight

120 kg + 40 kg = 160 kg

2. Determine the load capacity of each caster.

(Load weight x Safety factor) ÷ Number of casters = Load capacity of each caster

(160 kg x 1.25) ÷ 4 = 50 kg

Each of the casters selected for this new cart must have a load capacity of at least 50 kg.

Determining the load weight limit of an existing cart

To determine the load weight limit of an existing cart, multiply the manufacturer's listed load capacity for the weakest caster by the number of casters on the cart. When considering the number of casters on the cart, include only the casters that the load rests on. For example, do not include centrally pivoting casters or central axle casters.

Example: Calculating the load weight and material weight limits of an existing cart

Number of casters = 2 rigid and 1 swivel

Caster load capacity (provided by manufacturer) = 75 kg per rigid caster and 50 kg per swivel caster

Cart weight = 40 kg

Use: Smooth surface

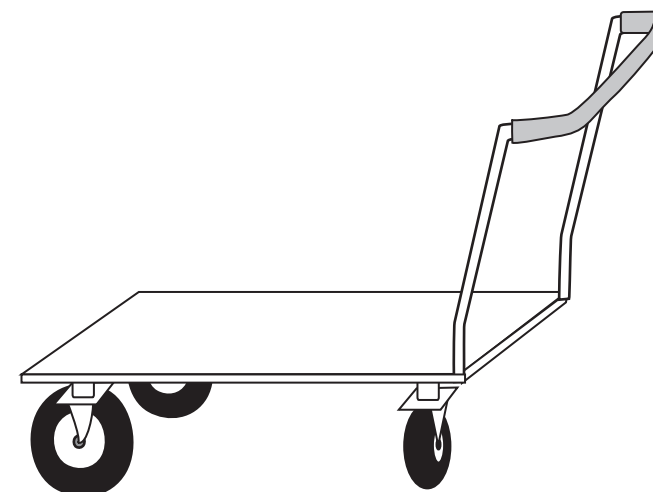

APPENDIX 5 sample calculations using load weight and load capacity

1. Determine the load weight limit.

Load capacity of weakest caster x Number of casters = Load weight limit

50 kg x 3 casters = 150 kg

2. Subtract the cart weight to determine maximum material weight (without safety factor).

Load weight limit – Cart weight = Material weight

150 kg – 40 kg = 110 kg

The load placed on this cart should weigh no more than 110 kg.

3. Build in a 25% safety factor (recommended).

Load capacity x Number of casters ÷ Safety factor = Load weight limit with safety factor

(50 kg x 3 casters) ÷ 1.25 = 120 kg

Load weight limit with 25% safety factor – Cart weight = Material weight with 25% safety factor

120 kg – 40 kg = 80 kg

The load weight limit of each cart should be labelled so workers can choose the appropriate cart for each task.

APPENDIX 6 cart identification form (existing carts)

Date: _____

Completed by (name): _____ Department: _____

Storage location of cart: _____

Equipment

Make: _____

Model: _____

Serial number: _____

Supplier: _____

Purchase cost: \$ _____

Cart checklist

Criteria	Yes	No
1. Does the supplier include routine maintenance instructions? If “Yes,” are they easy to follow?		
2. Does the supplier include preventive maintenance program instructions?		
3. Does the supplier offer training and in-services regarding maintenance? If “Yes,” are they easy to follow?		
4. Does the supplier identify a contact person for concerns?		
5. Can servicing be completed in-house?		
6. Are spare parts readily available from the supplier?		
7. Is the equipment easy to service and maintain?		
8. Is the equipment safe and stable?		
9. Does the supplier offer any after-sale services?		

Comments: _____

Date: _____

Working group: _____

Control measure	Person(s) responsible	In place by (date)	In place on time? (Y/N)	Potential barriers?

Stretch it out!

Hold each stretch for 15-30 seconds

Regular stretching can help to improve blood flow and reduce muscle tension and risk of injury. Perform each stretch slowly and without bouncing. If you feel abnormal discomfort, stop the stretch and consult your physician before continuing with a stretching program.

Neck Lower Back Chest
Upper Back Forearm & Wrist Back of Thigh
Shoulder Sidebend Calf
Triceps

Occupational Health & Safety Agency for Healthcare in BC (OHSAH)
 #301-1195 VW Broadway, Vancouver BC, V6H 3X5
 Tel: 778.328.8000 | Fax: 778.328.8001 | Web: www.ohsah.bc.ca

- Algood Casters Limited. 2004. How to select the correct Algood caster and wheel. <www.algood-casters.com/caster-selection.html> (April 28, 2005).
- Canadian Centre for Occupational Health and Safety. 1997. Manual materials handling — Health hazards. <www.ccohs.ca/oshanswers/ergonomics/mmh/hlth_haz.html> (April 28, 2005).
- Canadian Centre for Occupational Health and Safety. 1997. Pushing & pulling — Handcarts. <www.ccohs.ca/oshanswers/ergonomics/push2.html> (April 28, 2005).
- Darcor Ltd. and Ergoweb Inc. 2001. *The ergonomics of manual material handling: Pushing and pulling tasks*. Toronto: Darcor. <www.darcor.com/whatsnew.htm> (April 28, 2005).
- Doyle, E. 2002. Caster selection guide. <www.stanleymithco.com/Pages/cstrselection.html> (April 28, 2005).
- Eastman Kodak Company. 1986. *Kodak's ergonomic design for people at work*. 2nd ed. Toronto: John Wiley and Sons.
- Health and Safety Executive. 2004. *Getting to grips with manual handling: A short guide*. Suffolk: HSE Books.
- Hoozemans, M. J., A. J. van der Beek, et al. 1998. Pushing and pulling in relation to musculoskeletal disorders: A review of risk factors. *Ergonomics* 41 (6): 757–81.
- Industrial Accident Prevention Association. 2005. Manual materials handling. <www.iapa.on.ca/pdf/manmat.pdf> (April 28, 2005).
- Jilson Group, The. 2000. Caster technical guide. <www.jilson.com/selectguide.htm> (April 28, 2005).

- Oxford Caster. 2000. Casters, wheels, and material handling. <www.oxfordcaster.com> (April 28, 2005).
- PlasticWheels.com. 2002. Technical information. <www.plasticwheels.com/technical.htm> (April 28, 2005).
- US Architectural and Transportation Barriers Compliance Board. 2002. Americans with Disabilities Act (ADA) Accessibility Guidelines for Buildings and Facilities (ADAAG). Washington, DC.